

PROHEAT 2X[®] REVOLUTION[™] PET PRO

USER GUIDE
2066 SERIES

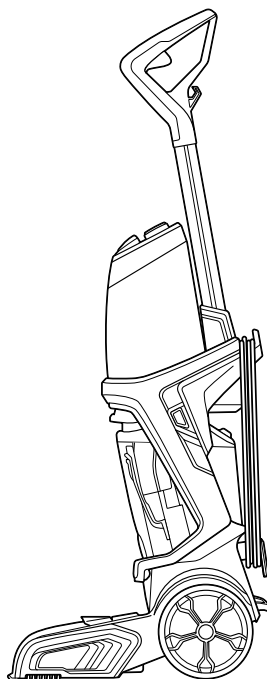
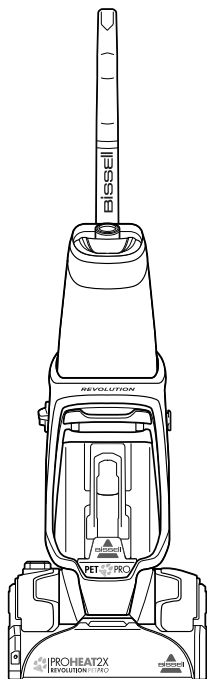

IMPORTANT SAFETY INSTRUCTIONS

READ ALL INSTRUCTIONS BEFORE USING YOUR DEEP CLEANER.

When using an electrical appliance, basic precautions should be observed, including the following:

WARNING





To reduce the risk of fire, electric shock, or injury:

- » Unplug from electrical socket when not in use and before cleaning, maintaining or servicing the appliance.
- » This appliance can be used by children aged from 8 years and above and persons with reduced physical, sensory or mental capabilities or lack of experience and knowledge if they have been given supervision or instruction concerning use of the appliance in a safe way and understand the hazards involved. Cleaning and user maintenance shall not be made by children without supervision.
- » Children should be supervised to ensure that they do not play with the appliance.
- » If the supply cord is damaged, it must be replaced by the manufacturer, its service agent or similarly qualified persons in order to avoid a hazard.
- » Do not run appliance over cord.
- » Keep hair, loose clothing, fingers, and all parts of body away from openings and moving parts of the appliance and its accessories.
- » Use only the type and amount of liquids specified under the Operations section of this guide.
 - » Do not leave appliance when plugged in.
 - » Always connect to a properly earthed electrical socket. Do not modify earthed plug.
- » Do not allow to be used as a toy.
- » Use only as described in the user guide.
- » Use only manufacturer's recommended attachments.
- » Do not use with damaged cord or plug.
- » Do not immerse in water or liquid. Use only on surfaces moistened by the cleaning process.
- » If appliance is not working as it should, has been dropped, damaged, left outdoors, or dropped into water; do not attempt to operate it and have it repaired at an authorized service center.
- » Liquid must not be directed towards equipment containing electrical components.
- » Do not pull or carry by cord, use cord as a handle, close door on cord, or pull cord around sharp edges or corners.
- » Keep cord away from heated surfaces.
- » Do not unplug by pulling on cord.
- » To unplug, grasp the plug, not the cord.
- » Do not handle plug or appliance with wet hands.
- » Do not put any object into openings.
- » Do not use with any opening blocked; keep free of dust, lint, hair, and anything that may reduce air flow.
- » Turn off all controls before unplugging.
- » Use extra care when cleaning on stairs.
- » Do not use to pick up flammable or combustible liquids, such as petrol, or use in areas where they may be present.
- » Do not pick up toxic material (chlorine bleach, ammonia, drain cleaner, etc.)
- » Do not use appliance in an enclosed space filled with vapors given off by oil base paint, some mothproofing substances, flammable dust, or other explosive or toxic vapors.
- » Do not pick up hard or sharp objects such as glass, nails, screws, coins, etc.
- » Keep appliance on a level surface.
- » Do not carry appliance while in use.
- » Unplug before attaching the TurboBrush™ tool.
- » Do not pick up anything that is burning or smoking, such as cigarettes, matches, or hot ashes.
- » If your appliance is fitted with a nonwireable BS 1363 plug it must not be used unless a 13 amp (ASTA approved to BS 1362) fuse is fitted in the carrier contained in the plug. Spares may be obtained from your BISSELL supplier. If for any reason the plug is cut off, it must be disposed of, as it is an electric shock hazard should it be inserted into a mains socket.
- » Do not expose to rain. Store indoors.
- » Always install float before any wet pick-up operation.
- » Plastic film can be dangerous. To avoid danger of suffocation, keep away from children.
- » Have servicing performed by a qualified repair person using only identical replacement parts. This will ensure that the safety of the product is maintained.

SAVE THESE INSTRUCTIONS

FOR OPERATION ON A 220-240 VOLT A.C. 50-60 HZ POWER SUPPLY ONLY.

This model is for household use only.

	Caution.
	Refer to instruction manual.
	This symbol means to recycle.
	Recycling to help the environment. Dispose of packaging at the applicable recycling collection point. This symbol means to recycle. Do not mix packaging with general household waste.
	This symbol on the product and/or accompanying documents means that used electrical and electronic products should not be mixed with general household waste. For proper treatment, recovery and recycling, please take this product to designated collection points. Please contact your local authority for further details of your nearest designated collection point.

Quick Start Guide

Assembly

WARNING

Do not plug in your deep cleaner until you are familiar with all instructions and operating procedures.

Your deep cleaner comes in four easy-to-assemble components and an accessory bag.

- Base
- Upper Handle
- Clean Water Tank
- Carry Handle

A Phillips screwdriver is required for Assembly in Step 3.

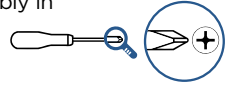

1

First, insert the (aluminum) Upper Handle at the top of the base until you hear a “click”. Do NOT put the clean tank on the machine until Step 5.

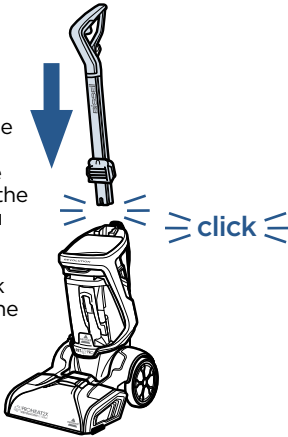

2

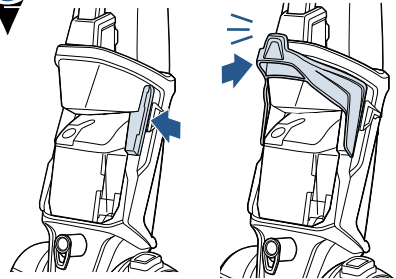

Next, align the carry handle with the slots on either side of the base (behind the power switch and cleaning mode switch). The carry handle will “click” into place.

3

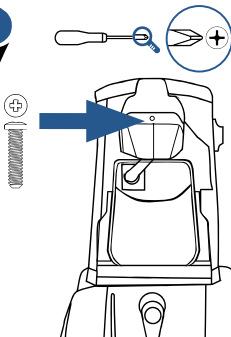

Use a Phillips screwdriver to secure the screw (found taped to upper handle) into the carry handle.

4

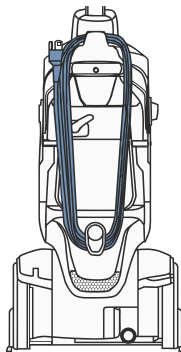

Wrap the cord around the carry handle and Quick Release™ Cord Wrap hook.

5

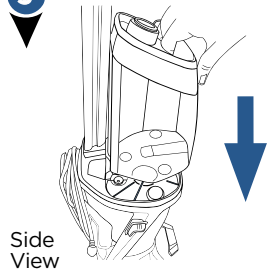

At the bottom of the upper handle, align the clean water tank with the grooves and slide the tank into place.

Thanks for buying a BISSELL carpet cleaner!

We love to clean and we're excited to share one of our innovative products with you. We want to make sure your carpet cleaner works as well as it does today for years to come, so this guide has tips on using (pages 7-12), maintaining (pages 13-17), and if there's a problem, troubleshooting (page 18).

In just a few simple assembly steps, you'll be ready to deep clean. Flip to the Quick Start Guide on page 3 and let's get started!

Package Contents

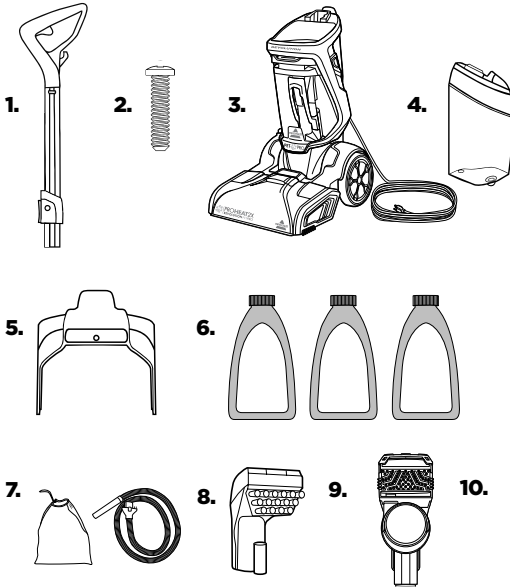

1. Upper Handle
2. 1 Screw attached to Upper Handle
3. Base with Dirty Water Tank
4. Clean Water Tank
5. Carry Handle
6. Trial Size BISSELL Formulas (3)
7. Accessory bag & hose
8. Tough Stain Tool
9. 2-in-1 Pet Upholstery Tool
10. Nozzle Clean Out Tool

NOTE: Standard accessories may vary by model. To identify what should be included with your purchase, please refer to the "Carton Contents" list located on the carton top flap.

Safety Instructions.....	2	Hose, Tools & CleanShot® . . .	10-12
Quick Start Guide.....	3	Maintenance & Care	13-17
Product View.....	5	Troubleshooting	18
Cleaning Formulas.....	6	Guarantee.....	20
Operations	7-9	Service.....	20

Getting to Know Your Deep Cleaner

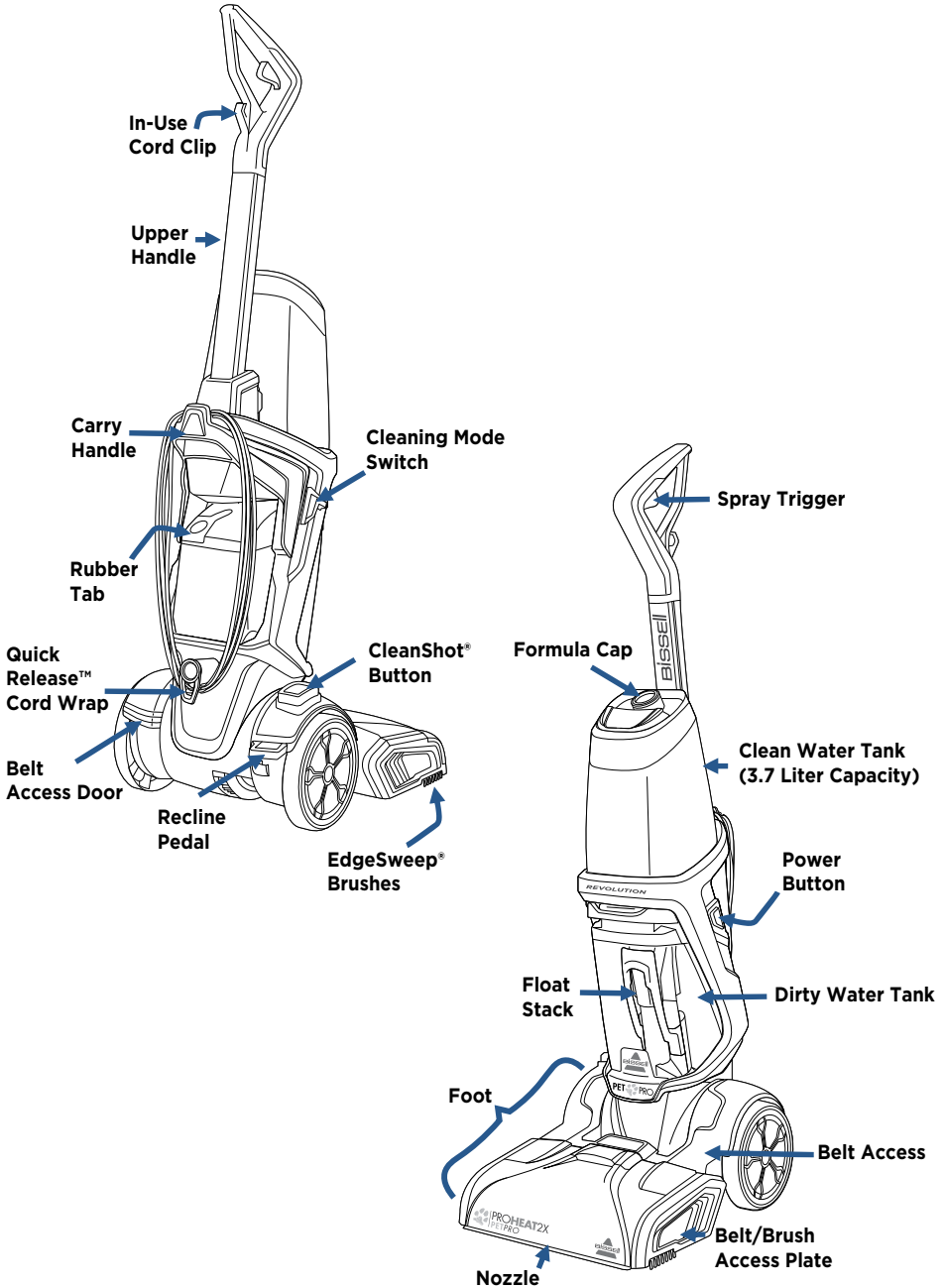

Cleaning Formulas

WARNING

To reduce the risk of fire and electric shock due to internal component damage, use only BISSELL cleaning fluids intended for use with the deep cleaner.









Keep plenty of genuine BISSELL formula on hand so you can clean whenever it fits your schedule.

Always use genuine BISSELL deep cleaning formulas. Non-BISSELL cleaning formulas may harm the machine and may void the guarantee.

PRETREAT PRE TREAT SPOTS AND STAINS TO IMPROVE CARPET CLEANING PERFORMANCE

	
Stain PreTreat	Pet Stain PreTreat
Pretreat to penetrate and loosen tough stains	Pretreat to help remove tough pet stains and odors

2X* CONCENTRATED CLEANING FORMULAS

WASH & PROTECT			WASH & REMOVE	WASH & REFRESH			WASH & SHINE
							
Professional Stain & Odour	Pet Stain & Odour	Stain & Odour	+ Oxy	Febreze™ Blossom & Breeze	Febreze™ Cotton Fresh	Natural Orange	Hard Floor Cleaner
Professional strength to remove extra tough stains and odours <i>Includes Scotchgard™ Protector</i>	Removes tough pet stains and contains patented odour removal technology <i>Includes Scotchgard™ Protector</i>	Removes tough stains and odours <i>Includes Scotchgard™ Protector</i>	Permanently removes tough stains like red wine, coffee, tea, cola and grape juice with Active Oxygen Technology	Powerful cleaning with a refreshing spring scent	Powerful cleaning with a refreshing clean scen	Powerful cleaning with a refreshing natural orange scent	Removes dirt and grime from sealed hard floor surfaces; leaves a natural shine

ONLY BISSELL Wash & Protect formulas protect from future stains with Scotchgard™ Protector. Scotchgard™ is a trademark of 3M®.

*60 mL of 2X concentrated formula is equivalent to 120 mL of non-concentrated formula.

Tips Before Carpet Cleaning

- If cleaning an entire room, consider moving your furniture to another area.
- Remove loose dirt and impediments.
- Pre-treat stains with BISSELL PreTreat to improve performance on tough stains and ground-in dirt.

Filling Your Clean Water Tank:

2X Concentrated Formula

1

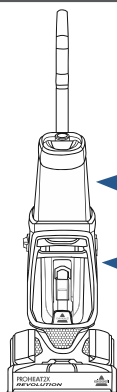

Clean Water Tank
(3.7 Litre)

Dirty Water Tank

The clean water tank is at the top of the machine.

2

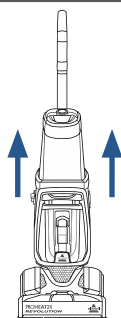

Lift the clean water tank straight up to remove from the machine.

3

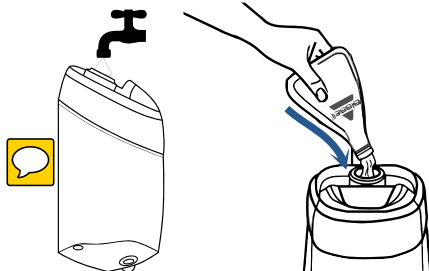

Unscrew the cap from the clean water tank. Add hot tap water to the water fill line. Next, reference the chart below for formula amounts to add to the tank. Twist cap back into place.

4

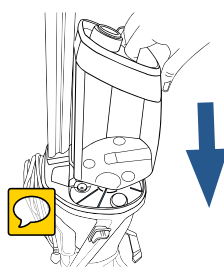

At the bottom of the upper handle, align the clean water tank with the grooves and slide the tank into place.

FORMULA FILLING INSTRUCTIONS

BISSELL 2X Concentrated Formulas

DEEP CLEAN MODE

Fill water to the Water Fill Line, then add 74 mL of formula.

EXPRESS CLEAN MODE

Fill water to the Water Fill Line, then add 37 mL of formula.

NOTE: Fill with hot (140°F/60°C MAX) tap water and add the appropriate BISSELL solution. **DO NOT USE BOILING WATER. DO NOT HEAT WATER OR TANK IN MICROWAVE.** Do not substitute BISSELL Cleaning Formula with other household cleaning products.

NOTICE: Do not over wet carpet. Be careful not to run over loose objects or edges of area rugs. Stalling the brush may result in premature belt failure.

Always use genuine BISSELL deep cleaning formulas. Non-BISSELL cleaning solutions may harm the machine and may void the guarantee.

Cleaning Your Carpet

1

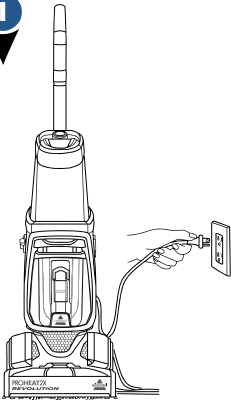

Plug into a properly earthed outlet.

2

Select cleaning mode:

Deep Clean
Delivers a deep clean to your carpet.

Express Clean
Provides a lighter clean with about 1 hour of dry time.

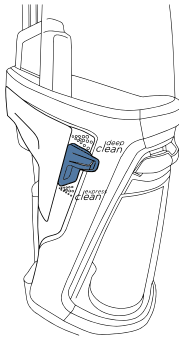

3

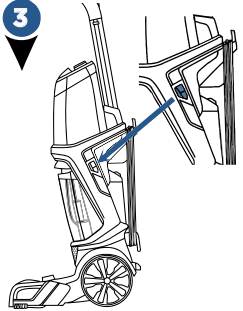

Press the power button to turn the machine on. To recline your machine for use, press the recline pedal with your foot.

4

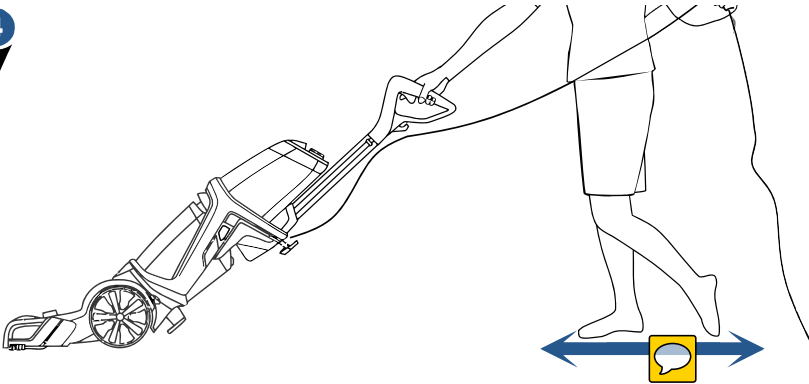

Deep Clean Mode:

1. Press the spray trigger to apply solution while making **2 slow wet passes** - 1 forward and 1 back.
2. Release the trigger.
3. Make **2 slow dry passes** - 1 forward and 1 back, to suck up the dirty solution. **(Do not hold down the trigger for this step.)**

NOTE: For best cleaning performance, clean with your machine in Deep Clean Mode.

Express Clean Mode:

1. Press the spray trigger to apply solution while making **2 wet passes** - 1 forward and 1 back.
2. Release the trigger.
3. Make **2 dry passes** - 1 forward, 1 back to suck up the dirty solution. **(Do not hold down the trigger for this step.)**

NOTE: In Express Clean Mode, the dirty tank will not get as full as when cleaning with Deep Clean Mode.

NOTICE: To prevent damage to Berber carpets, avoid repeated strokes in the same area.

Bare Floor Cleaning*

*Select models only

WARNING

WARNING: To reduce the risk of fire and electric shock when cleaning a hard floor, the BISSELL bare floor tool must be used and is only to be used with BISSELL Wash & Shine Hard Floor Cleaner formula intended for use with this appliance.

NOTE: The bare floor tool that is compatible with the ProHeat 2X Revolution may not be included. It is available for purchase by contacting our team by phone or visiting us online at BISSELL.com.

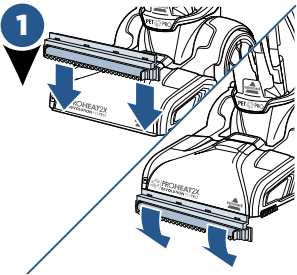

1 With the machine unplugged, attach the bare floor tool to the bottom of the machine by lining the tool to the edge of the nozzle. Rotate down until it clicks into place.

Follow filling instructions on page 10 or 11 and switch cleaning mode to Express Clean.

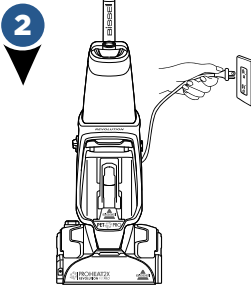

2 Plug into a properly grounded outlet and press the power button.

Clean by pressing the trigger for 1 wet pass forward, 1 wet pass back, and then release the trigger and make 1 dry pass forward, 1 dry pass back.

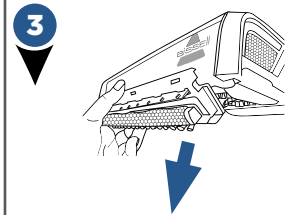

3 When finished, unplug the machine and remove the bare floor tool by rotating the tool up to unhook from the nozzle.

Rinse and let dry before storing. Refer to page 13 for emptying the dirty water tank. Refer to page 14 for cleaning your machine before storing.

Area Rug Cleaning

Important! Please check manufacturer's tag before cleaning area rugs for any specialized cleaning instructions. We do not recommend deep cleaning delicate, silk, wool, antique or area rugs without a manufacturer's tag.

Regularly clean your high-traffic area rugs in Express Clean Mode:

- Check the manufacturer's tag.
- Select Express Clean Mode.
- When cleaning area rugs, place the rug on a sealed surface to test for colorfastness in an inconspicuous area. Your cleaner should not be used on unsealed surfaces.
- **Important:** Keep the foot of the deep cleaner perpendicular to the rug's edge with each cleaning pass to prevent damage.

Cleaning with Hose & Tool

1

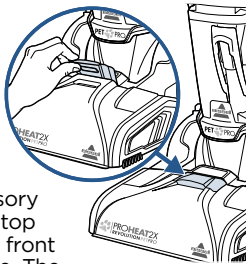

Lift the accessory hose door on top of foot on the front of the machine. The door flips toward the machine to open.

— Keep hair, loose clothing, fingers, and all parts of body away from openings and moving parts. Brushroll continues to rotate when in the upright position.

— Brushroll continues to turn while product is turned on and handle is in upright position. To avoid damage to carpet, rugs, furniture and flooring, avoid tipping cleaner or setting it on furniture, fringed area rugs, or carpeted stairs during tool use.

— The brushroll remains on while cleaning with the hose and tool. Do not allow cleaner to sit in one location for an extended period of time, as damage to floor can result.

2

Insert the hose and snap into place. Be sure the colored hose release clip is facing out, away from machine.

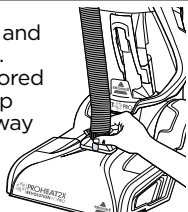

4

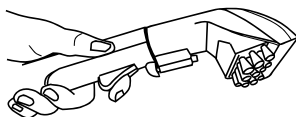

Press the spray trigger button to spray the soiled area, then slowly move tool back and forth over the area.

Release the trigger to suck up the dirty solution. Work in small sections until the area is clean.

When finished cleaning, turn the machine on to suction up warm clean water to rinse the inside of the hose and tool. Detach the hose and tool and close the accessory hose door. Let the hose and tool air dry before storing.

3

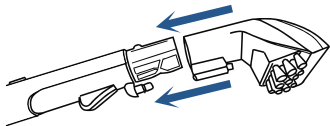

Attach the tool to the end of the hose. (Tools may vary by model.) Press the power button to turn machine on.

NOTE: If using the **Deep Reach Tool** (select models only) or **Pet Stain Tool** (select models only) be sure the needles of the tool are pressed down into the carpet so the spray gets into the carpet fibers.

Cleaning with CleanShot®

1

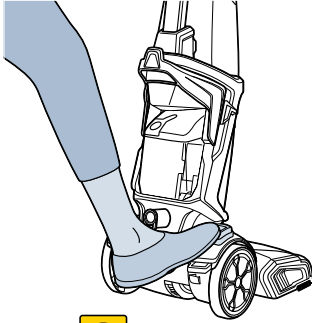

Press the CleanShot® button with your foot. The window of the button will be green and show an "I" symbol when it is on.

2

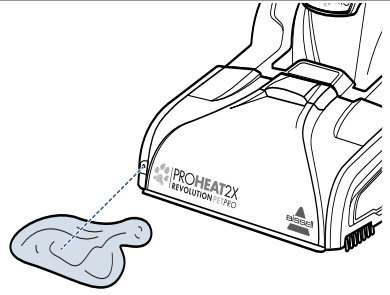

Spray will continue until you turn it off. To turn CleanShot® off, press the button with your foot. The window of the button will be red and show an "O" symbol when it is off.

Completely cover the stain with CleanShot® spray. Allow the stain to soak. To extract, maneuver the foot of the machine over the stain to brush and remove.

NEW! 2-in-1 Pet Upholstery Tool

*Make sure your clean tank has water & formula to use the tool in wet mode..

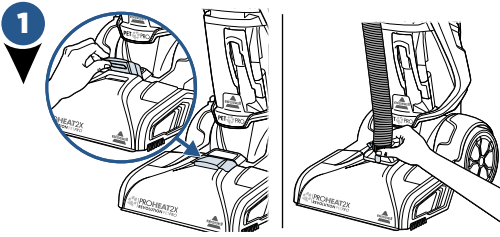

Follow hose plug-in instructions from steps 1 & 2 on page 14.

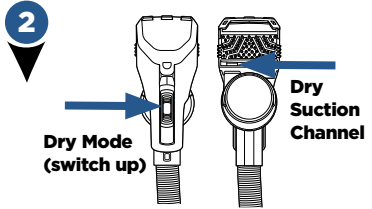

Attach the tool and select dry mode to first pick up dry debris and pet hair. The suction will be at the lower part of the tool, near the dry cup.

DRY MODE NOTE: Use a “raking” motion to clean. Start with the tool farthest away and rake in small increments as you bring the tool toward you. The rubber nubs will help attract hair to the suction channel.

3 Empty the cup when it fills with hair and debris.

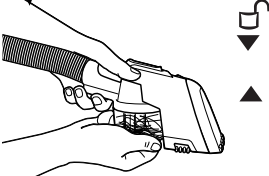

Turn off the machine. Hold the cup and twist counterclockwise. Line up the arrow with the unlock symbol and remove.



Take off the cup to empty hair and debris.



Remove hair that may wrap around the filter.

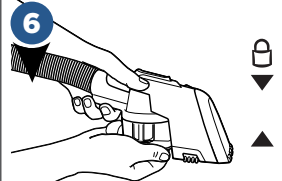

To reattach the cup, line up the cup to the tool indents, and rotate clockwise. The arrow will line up with the locked icon when secured.

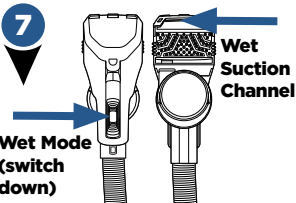

To Deep Clean, move the switch to wet mode. Press the trigger to spray your water and formula; use the top of the nozzle to extract stains and odors.

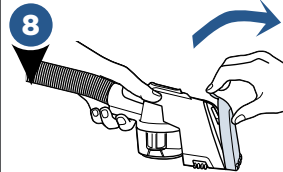

To remove any hair or trapped debris from the nozzle, first turn off the machine. Pull the nozzle tab away from the tool to remove and rinse under running water.

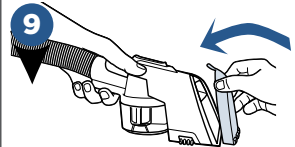

Replace the tool by lining up the nozzle edge and snap into place. Before storing, make sure all hair is removed from the dry cup and nozzle has been rinsed under running water.

WET MODE NOTE: Start from the area farthest away. Hold the trigger down, and pull the tool toward you. Keep the tool in contact with the surface as you pull. You will see extraction through the nozzle.

Empty Dirty Water Tank

⚠️ WARNING

To reduce the risk of fire, electric shock or injury, turn power OFF and disconnect plug from electrical outlet before performing maintenance or troubleshooting.

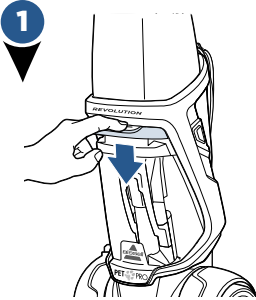

1
To release dirty water tank, press down on the colored tank handle.

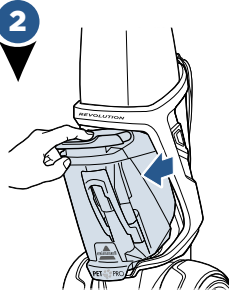

2
Tilt the tank slightly toward you.

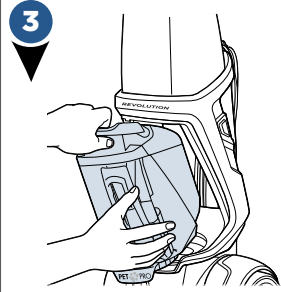

3
Grab the handle and tank with both hands and pull the dirty water tank up and away to remove.



4
For quick empty: Pull the rubber tab and tilt to pour. (Located at the corner of the top of the tank.)

When closing the rubber tab, make sure all edges are sealed tight.

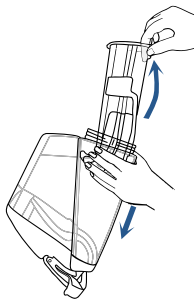

For final clean and rinse: Unscrew the ring at the bottom of tank.

Gently remove the float stack, rinse, and clean.

Once clean, return float stack into the tank by lining up the arrows so they point at each other. This is the only way the float stack will fit into the tank.

With the arrows aligned, the float stack should lock into place.

Return the ring and twist to lock. Water may leak if the ring is not fully tightened.



5
Clean the red filter below the dirty tank by wiping off any remaining dirt or debris.

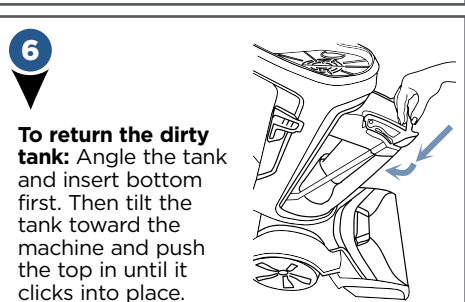

6
To return the dirty tank: Angle the tank and insert bottom first. Then tilt the tank toward the machine and push the top in until it clicks into place.

Did You Know?

The Float Stack is what prevents your dirty tank from overflowing.

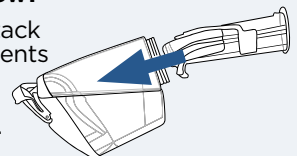

Cleaning Machine After Use

WARNING

To reduce the risk of electric shock, turn power switch off and disconnect plug from electrical outlet before performing maintenance or troubleshooting checks.



First, fill the clean water tank with warm tap water and then empty it all to rinse. Then fill again with warm tap water and return the tank to the machine. Twist cap back on tightly.

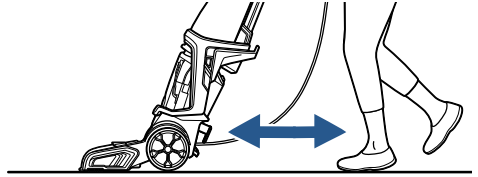

To flush and rinse the machine: Turn the machine on and press the trigger for 15 seconds while making back and forth passes on a section of carpet.

Finally, release the trigger and extract the water.

See page 13 to clean the dirty tank from the water that was just extracted. Empty the clean water tank and let dry before storing.

Wipe your machine's exterior with a soft cloth. Store machine in a protected dry area.

NOTICE: To reduce the risk of a leaking condition, do not store unit where freezing may occur. Damage to internal components may result.

Brush Roll & Nozzle Care

⚠️ WARNING

To reduce the risk of electric shock, turn power switch off and disconnect plug from electrical outlet before performing maintenance or troubleshooting checks.

NOTE: Be sure to clean the brush rolls and nozzle before storing your machine. Follow these steps if your nozzle becomes clogged with hair or debris.

1

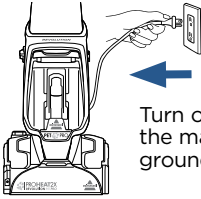

Turn off and unplug the machine from the grounded outlet.

2

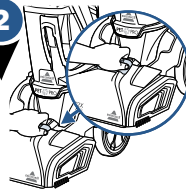

Remove the nozzle from the foot: scoop and grip the Accessory Hose Door. Pull up to remove the nozzle.



3

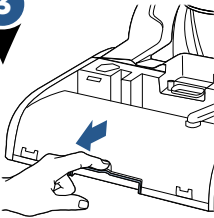

Pull forward the nozzle wire on the front of the brush roll cover for release.

4

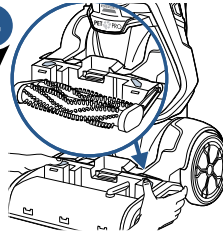

To reveal the brush rolls. Press on the two release buttons and lift straight up.

5



At this point, the nozzle and brush roll cover can be rinsed under running water and the nozzle clean out tool can be inserted to unclog hair or debris.

6

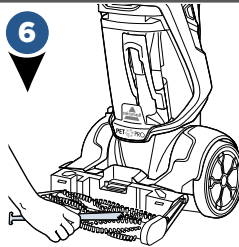

Use the comb to brush out the debris or hair from the brush rolls.

7

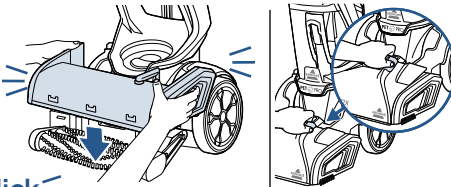

When finished, return the brush roll cover by pushing it straight down. You will hear a click from each "push" button when the cover is pushed down into place. Ensure the nozzle wire on the front of the brush roll cover has also snapped back into place. Line up the nozzle from the edge near the floor and rotate to snap back into place.

Replacing Belts & Brush Rolls

⚠️ WARNING

To reduce the risk of electric shock, turn power switch off and disconnect plug from electrical outlet before performing maintenance or troubleshooting checks.

What you will need: 1 Phillips screwdriver & 1 flathead screwdriver

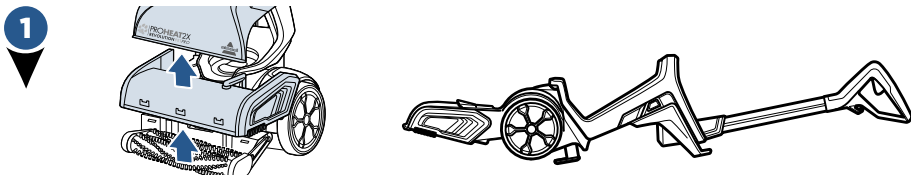

While the machine is upright, unplug the machine and remove both tanks. Remove the nozzle and brush chamber cover (see steps in Brush Roll & Nozzle Care). Press the recline pedal and lay the machine on its back.

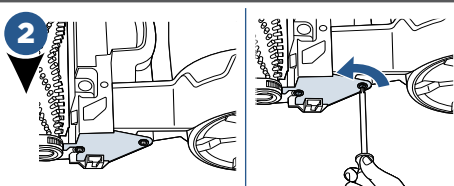

With the machine laying on its back, locate the belt access plate. Use a Phillips-head screwdriver to remove the belt access plate screw.

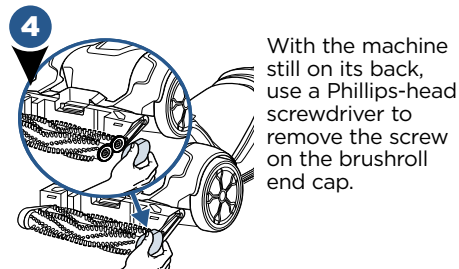

With the machine still on its back, use a Phillips-head screwdriver to remove the screw on the brushroll end cap.

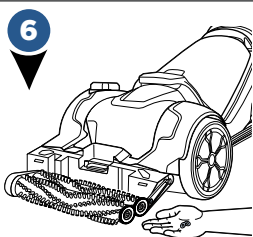

There are washers at the ends of the brush rolls, be careful that these do not fall off or get lost.

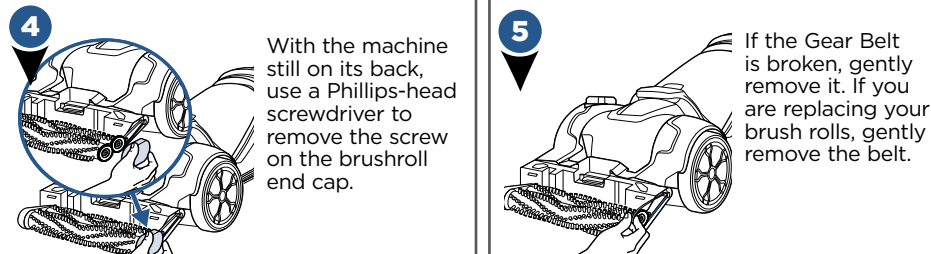

If the Gear Belt is broken, gently remove it. If you are replacing your brush rolls, gently remove the belt.

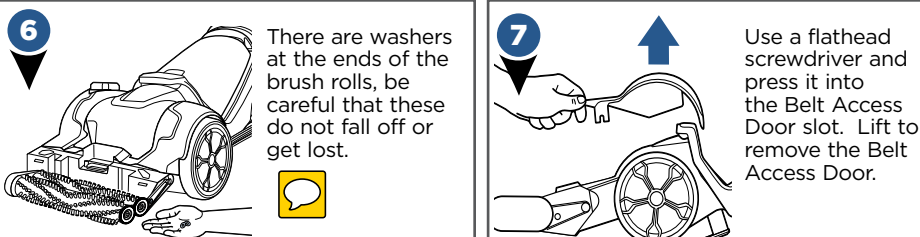

Use a flathead screwdriver and press it into the Belt Access Door slot. Lift to remove the Belt Access Door.

Replacing Belts & Brush Rolls (Continued)

8

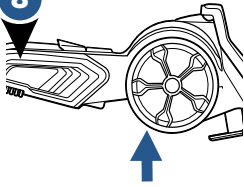

Turn the machine on its side and use a Philips screwdriver to remove the screw just underneath the wheel. Slide the wheel down to remove.

NOTE: To replace brush rolls, remove them from the metal posts and replace. Make sure the metal post goes completely through the end of the brush roll. The brush roll bristles should be aligned in a 'V' pattern as pictured.

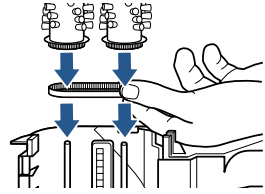

Align brush rolls with belt at other end. To ensure alignment, hold the end of one brush roll and twist. The other brush roll rotates with it. **Check that washers are in place.** Reassemble the belt and end cap, securing with screws you removed.

9

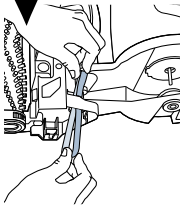

If the flat belt is broken, gently remove the belt. If it needs replacing for any reason, the gear belt should already be removed before removing the flat belt. Rotate the machine back to its side. Feed the new flat belt through the opening so that it wraps around the red pulley.

10

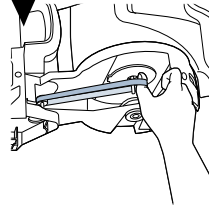

Keep it wrapped on the red pulley and adjust the machine so it is laying on its back again. Use your thumb to stretch the flat belt back to wrap around the metal axle.

11

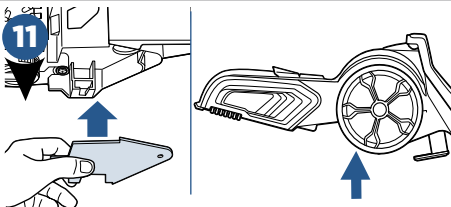

Resecure the Belt/Brush Access Plate:

Slide the wheel up back into the slot and secure with the screw that was removed.

12

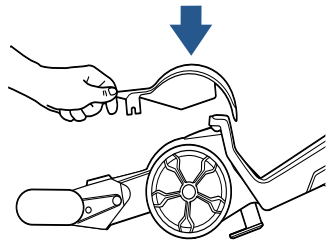

Snap the Belt Access Door back down into place.

NOTE: See **Step 7 on page 15** for how to put the brush roll cover and nozzle back in place.



WARNING

To reduce the risk of electric shock, turn power switch off and disconnect plug from electrical outlet before performing maintenance or troubleshooting checks.

Problem	Possible causes	Remedies
Reduced or No Spray Through Foot of Machine	Clean water tank may be empty	Refill tank
	Clean water tank may not be seated completely	Turn power OFF; remove and reseal tank
No spray through hose & tool	The hose to your machine is not primed or may have lost prime	<ol style="list-style-type: none"> 1. With the machine off and unplugged, remove the nozzle from the foot. Place a ball point pen in the black cylinder next to the screw. When water bubbles up, remove the pen. Reassemble the nozzle and hose 2. Hold end of hose below water level in tank to prime 3. With the clean tank full of water, the machine OFF and RECLINED, press the CleanShot® button ON and wait for the CleanShot® to drain for a few seconds; This will re-prime the machine
	Clean Water tank may be empty	Refill the Clean Water Tank
	Clean Tank may not be seated properly	Turn power OFF; Remove and reseal the clean water tank
No Spray Through CleanShot®	Clean Water tank may be empty	Refill the Clean Water Tank
	Clean Tank may not be seated properly	Turn power OFF; Remove and reseal the clean water tank
	The machine is not reclined	Press the Recline pedal and bring the handle down to recline the machine
	Pump may have lost prime	With the machine off and unplugged, remove the nozzle from the foot. Place a ball point pen in the black cylinder next to the screw; When water bubbles up, remove the pen; Reassemble the nozzle before cleaning again
CleanShot® Continues Spray When Machine is Off	CleanShot® button is not in the "OFF" position	Press the CleanShot® button to turn it off. The button window will show the color red and a "O" symbol when it is in the off position
Loss of suction power	Dirty tank may not be seated properly	Pick up the dirty tank and reseal so it fits in the unit
	Dirty tank has picked up maximum amount of dirty water and has reached full line	Empty dirty tank
	Rubber tab on dirty water tank is not sealed tight	Check the rubber tab on the dirty water tank and press firmly on all edges to secure it tightly (see step 4 on page 15 for detail)
	Accessory hose door may not be closed tightly in place	Check the accessory hose door and make sure it is closed tightly - it should be locked into place
	Nozzle may be clogged from pet hair or debris	Use the nozzle clean out tool and follow steps on page 15 for "Cleaning Nozzle"
	Brush roll cover not fully snapped into place	Remove the nozzle and brush roll cover; Follow step 7 from page 15 and make sure you hear both buttons click into place
No power	Cleaning mode switch mistaken for power button	Press the red power button on the left side of the machine to turn the machine on
	Outlet may not be active	Try plugging in a different device that uses a grounded outlet to test for power from the outlet
Leaking tank	Tank may have been over-filled	1. Make sure your tank has the water and formula in it that you've prepared
	Water may be caught in space between the tank and the tank's handle	<ol style="list-style-type: none"> 2. With the cap twisted ON tightly, hold your tank at an angle, over a sink or drain, so any extra water can pour out of the space 3. Wipe the tank dry with a cloth

Notes

Consumer Guarantee

This Guarantee only applies outside of the USA and Canada. It is provided by BISSELL International Trading Company BV ("BISSELL").

This Guarantee is provided by BISSELL. It gives you specific rights. It is offered as an additional benefit to your rights under law. You also have other rights under law which may vary from country to country. You can find out about your legal rights and remedies by contacting your local consumer advice service. Nothing in this Guarantee will replace or lessen any of your legal rights or remedies. If you need additional instruction regarding this Guarantee or have questions regarding what it may cover, please contact BISSELL Consumer Care or contact your local distributor.

This Guarantee is given to the original purchaser of the product from new and is not transferable. You must be able to evidence the date of purchase in order to claim under this Guarantee.

Limited 6 Year Guarantee (from the date of purchase by original purchaser)

Subject to the *EXCEPTIONS AND EXCLUSIONS identified below, BISSELL will repair or replace (with new or remanufactured components or products), at BISSELL's option, free of charge, any defective or malfunctioning part or product.

BISSELL recommends that the original packaging and evidence of the date of purchase be kept for the duration of the Guarantee period in case the need arises within the period to claim on the Guarantee. Keeping the original packaging will assist with any necessary re-packaging and transportation but is not a condition of the Guarantee.

If for your product is replaced by BISSELL under this Guarantee, the new item will benefit from the remainder of the term of this Guarantee (calculated from the date of the original purchase). The period of this Guarantee shall not be extended whether or not your product is repaired or replaced.

*EXCEPTIONS AND EXCLUSIONS FROM THE TERMS OF THE GUARANTEE

This Guarantee applies to products used for personal domestic use and not commercial or hire purposes. Consumable components such as filters, belts and mop pads, which must be replaced or serviced by the user from time to time, are not covered by this Guarantee.

This Guarantee does not apply to any defect arising from fair wear and tear. Damage or malfunction caused by the user or any third party whether as a result of accident, negligence, abuse, neglect, or any other use not in accordance with the User Guide is not covered by this Guarantee.

An unauthorised repair (or attempted repair) may void this Guarantee whether or not damage has been caused by that repair/attempt.

Removing or tampering with the Product Rating Label on the product or rendering it illegible will void this Guarantee.

SAVE AS SET OUT BELOW BISSELL AND ITS DISTRIBUTORS ARE NOT LIABLE FOR ANY LOSS OR DAMAGE THAT IS NOT FORESEEABLE OR FOR INCIDENTAL OR CONSEQUENTIAL DAMAGES OF ANY NATURE ASSOCIATED WITH THE USE OF THIS PRODUCT INCLUDING WITHOUT LIMITATION LOSS OF PROFIT, LOSS OF BUSINESS, BUSINESS INTERRUPTION, LOSS OF OPPORTUNITY, DISTRESS, INCONVENIENCE OR DISAPPOINTMENT. SAVE AS SET OUT BELOW BISSELL'S LIABILITY WILL NOT EXCEED THE PURCHASE PRICE OF THE PRODUCT.

BISSELL DOES NOT EXCLUDE OR LIMIT IN ANY WAY ITS LIABILITY FOR (A) DEATH OR PERSONAL INJURY CAUSED BY OUR NEGLIGENCE OR THE NEGLIGENCE OF OUR EMPLOYEES, AGENTS OR SUBCONTRACTORS; (B) FRAUD OR FRAUDULENT MISREPRESENTATION; (C) OR FOR ANY OTHER MATTER WHICH CANNOT BE EXCLUDED OR LIMITED UNDER LAW.

Consumer Care

If your BISSELL product should require service or to claim under our limited guarantee, please contact us as follows:

Website:

www.bisselldirect.co.uk

Email:

UKSupport@bissell.com

Telephone:

0344-888-6644

Write:

BISSELL Homecare (Overseas) Inc.
Ground Floor
226 Berwick Avenue
Slough, Berkshire, SL1 4QT
United Kingdom

Spares are available for purchase.

To purchase visit www.4bissell.co.uk

Visit the BISSELL website: www.bisselldirect.co.uk

When contacting BISSELL, have model number of cleaner available.

Please record your Model Number: _____ Please record your Purchase Date: _____

NOTE: Please keep your original sales receipt. It provides proof of the date of purchase in the event of a Guarantee claim. See Guarantee for details.



©2017 BISSELL Homecare, Inc
Grand Rapids, Michigan
All rights reserved. Printed in China
Part Number 161-2614 06/17 RevD
Visit our website at: www.BISSELL.com
Scotchgard is a trademark of 3M