



# DC741 Built-under & DC941 Built-In Double Oven

Installation, use and maintenance



---

## Contents:

3	Important information
4	Important safety notes
6	Before first use
7	Notes on usage
8	Oven controls and use
10	Setting the time/clock
10	Minute minder
11	Semi-automatic cooking
12	Automatic cooking
13	Care and maintenance
14	Changing the oven lamp
16	Removing the oven door(s)
17	Troubleshooting
19	Mains electricity connection
21	Installation
22	Appliance dimensions
23	Energy efficiency information

## Important

This appliance must only be used for the purpose for which it is intended, i.e. domestic cooking. Any other use could be dangerous and may lead to premature failure of the appliance.

The CDA Group Ltd cannot be held responsible for injuries or losses caused by incorrect use or installation of this product. Please note that CDA reserve the right to invalidate the guarantee supplied with this product following incorrect installation or misuse of the appliance.

This appliance is not designed to be used by people (including children) with reduced physical, sensorial or mental capacity, or who lack experience or knowledge about it, unless they have had supervision or instructions on how to use the appliance by someone who is responsible for their safety.

Under no circumstances should any external covers be removed for servicing or maintenance except by suitably qualified personnel.

### **User information:**

- Ovens become hot during and immediately after use.
- The oven door can become hot during operation.
- After use, please ensure that the control knobs are in the 'Off' position.
- Keep children away from the appliance when in use, and immediately after use.
- Keep the oven door closed when the appliance is in use.

---

**Appliance information:**

Please enter the details on the appliance rating plate below for reference, to assist CDA Customer Care in the event of a fault with your appliance and to register your appliance for guarantee purposes.

Appliance Model	
-----------------	--

Serial Number	
---------------	--

**EU Declarations of Conformity:**

This oven has been designed, constructed and marketed in compliance with safety requirements of EU Directive 2014/35/EU (LVD) and requirements of EU Directive 2014/30/EU (EMC).

This appliance has been manufactured to the strictest standards and complies with all applicable legislation, including Electrical safety (LVD) and Electromagnetic interference compatibility (EMC). Parts intended to come into contact with food conform to 1935/2004/EC.

**IMPORTANT INFORMATION FOR CORRECT DISPOSAL OF THE PRODUCT IN ACCORDANCE WITH EC DIRECTIVE 2012/19/EU.**

At the end of its working life, the product must not be disposed of as urban waste. It must be taken to a special local authority differentiated waste collection centre or to a dealer providing this service.

Disposing of a household appliance separately avoids possible negative consequences for the environment and health deriving from inappropriate disposal and enables the constituent materials to be recovered to obtain significant savings in energy and resources. As a reminder of the need to dispose of household appliances separately, the product is marked with a crossed-out wheeled dustbin. 

## Important

- Read the user instructions carefully before using the oven for the first time.
- Follow the instructions for first use of the oven.
- Clean the oven regularly.
- Steam cleaners must not be used when cleaning this appliance.
- Remove spills as soon as they occur.
- Always use oven gloves when removing shelves and trays from the ovens.
- Do not allow children near the oven when in use.
- Do not allow fat or oils to build up on the oven shelves, grill pan or oven base.
- Do not place any cooking utensils or plates directly on the oven base.
- Keep the oven door closed when the oven is in use.
- Do not grill food containing fat without using the grill pan grid.
- Do not cover the grill pan grid or the oven walls with aluminium foil.
- Do not use the oven tray for roasting.

- 
- Do not perform maintenance or cleaning of the oven without first switching off the electricity supply. If the oven has recently been used, allow to cool.
  - Do not place hot enamel parts in water. Leave them to cool first.
  - Do not allow vinegar, coffee, milk, saltwater, lemon or tomato juice to remain in contact with enamel parts.
  - Do not use abrasive cleaners or powders that will scratch the surface of the enamel.
  - Do not attempt to repair the internal workings of your oven.
  - The oven is equipped with a safety thermostat which will switch off the oven in the event of the oven overheating. If the safety thermostat should switch off the power, you must wait for the oven to cool down before using it again.
  - Do not cover the oven floor with aluminium foil.

## **First use of the oven**

The metal casing of this appliance has been coated with a preservative to protect it during transport and storage. This should be removed during installation by using a non-abrasive stainless steel cleaner. Always follow the instructions given with the cleaner being used.

Before using the oven for the first time we recommend that you clean both oven cavities with soapy water, rinse carefully and then heat on each of the below programmes at maximum temperature for the specified time. A slightly unpleasant smell may be produced, caused by grease remaining on the oven elements from the production process.

### Top oven

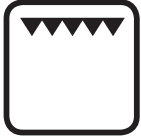

15 minutes full grill



60 minutes conventional

### Lower oven



60 minutes fan oven

### Please note:

- This oven has been fitted with a cooling fan to achieve maximum efficiency and to maintain low surface temperatures. The cooling fan will switch on automatically when the oven is switched on and runs for a while after the oven has been switched off - the length of time can vary and will be increased by poor ventilation.
- The oven light remains on for every cooking function.
- Do not switch off the oven if you have set a programme for semi-automatic or automatic cooking as this will cancel the programme.
- The current time must be set on the programmer/timer for the cooking functions to work properly (see page 10).

# Oven controls and use

## Cooking function knobs

To set the function, turn the cooking function knob for the required oven clockwise to the required function. Each of the oven functions uses different elements within the oven to offer you the best choice of cooking every time. These are explained below:



### Conventional oven

This function uses the top and bottom heating elements only with a temperature between 50°C and 250°C.

Natural convection creates a perfect cooking zone in the centre of the oven, ideal for dark fruit cakes and pastries.



### Warming oven

This function uses the bottom heating element only with a temperature set between 50°C and 250°C. This natural heat is perfect for dough proving and blind-baking.



### Grill

This function radiates the heat from the grill element and the top element.

This fully temperature variable grill is ideal for grilling a full family meal. It can be set between 50°C and 250°C.

## When grilling, please note:

- Always grill with the oven door closed.
- Put the grill pan as close to the grill as possible.
- Do not grill for more than 30 minutes at a time.
- Preheat the grill for a few minutes with the oven door closed.





### **Oven Lamp**

This function switches on the oven light in the cavity.  
Please note: the oven light will operate on all cooking functions



### **Defrost**

Using the fan only this oven function circulates the air around the oven cavity, speeding up the natural defrost process (1kg takes approximately one hour, depending on the type of food).



### **Fan Oven**

Using the circular element and the fan with a temperature between 50°C and 250°C, this cooking function blows the air into and around the oven cavity. Both cooking temperatures and cooking times can be reduced for a more energy efficient cooking programme. This function is perfect for cooking various food types simultaneously as foods are sealed quickly to prevent flavour transfer.

## **Temperature knob**

- To set the temperature, turn the temperature knob for the required oven clockwise to the required temperature.
- Once the oven has reached the required temperature, the temperature indicator lamp on the control panel will switch off.
- The temperature indicator lamp will light up when the oven elements are working.

## Programming the oven

### Please note:

- The semi-automatic and automatic cooking programmes will only work with the **main (lower) oven**.
- The alert beep will cut off after two minutes if it is not switched off manually.
- **The current time must be set in order for the functions to work. If you are unsure whether the current time is set, switch off the appliance at the mains supply for approximately 10 seconds and then turn it back on. Set the time as per the instructions below.**

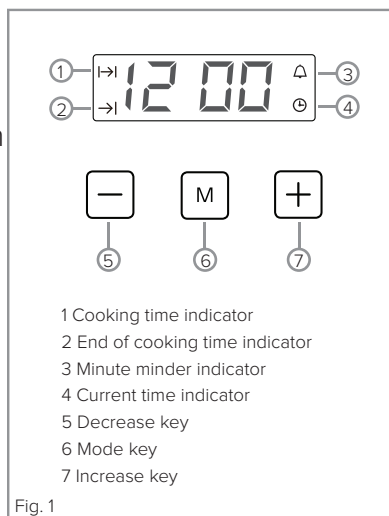

### Setting the clock

The clock is preset to 12:00, and will revert to this after a power failure. When the current time indicator is flashing, touch  $\oplus$  or  $\ominus$ . When the correct time is shown on the display, the clock will set after approximately five seconds' delay.





To change the clock once it has been set, touch  $\text{M}$  repeatedly until the current time indicator flashes, then touch  $\oplus$  or  $\ominus$ . When the correct time is shown on the display, the clock will set after approximately five seconds' delay.

### The minute minder

The minute minder can be used when the oven is switched on or off.

It can be set for up to 23 hours and 59 minutes.

### **To set the minute minder:**

- Touch  repeatedly until the minute minder indicator flashes.
- Then touch  or  to select the required duration for the minute minder. When the correct duration shows on the display, either touch  or wait for approximately five seconds. The minute minder indicator will remain lit to confirm the minute minder is on.
- When the countdown is complete, there will be an alert beep which will continue for two minutes and the minute minder indicator will flash. To switch off the alert beep, touch any key.



### **Please note:**

At the end of the countdown, the minute minder will not switch off the oven. Remember to turn off the oven manually.

### **Semi-automatic cooking**

The main oven can be set to switch off automatically at a preset time up to a maximum of 10 hours.

### **To set a semi-automatic cooking programme:**

- Select the oven function and temperature (the oven will switch on).
- Touch  until the cooking time indicator flashes.
- Then touch  or  to select the required duration for the semi-automatic cooking programme. When the correct duration shows on the display, wait for approximately five seconds. The cooking time indicator will remain lit to confirm the semi-automatic programme is on.

- When the cooking time is complete, there will be an alert beep which will continue for two minutes and the cooking time indicator will flash. To switch off the alert beep, touch any key.
- Turn the control knobs to the off position.



**Please note:**

At the end of the cooking programme, remember to turn off the oven manually.

**Automatic cooking**

The main oven can be set to switch on and off automatically at preset times up to a maximum of 10 hours.

To set an automatic cooking programme, follow the steps for setting a semi-automatic programme above, and then:

- Touch  until the end of cooking time indicator flashes.
- Then touch  or  to select the required end of cooking time.  
When the correct time shows on the display, wait for approximately five seconds. The cooking time and end of cooking time indicators will remain lit to confirm the automatic programme is on.
- The oven will switch off until the automatic programme starts. When the programme starts, the cooking time indicator will switch off
- When the cooking time is complete, there will be an alert beep which will continue for two minutes and the end of cooking time indicator will flash. To switch off the alert beep, touch any key.

**Please note:**

At the end of the cooking programme, **remember to turn off the oven manually (at the control knobs)**. If you have not switched the

oven off at the control knobs, pressing a control panel key will re-activate the previously set function.

## Care and maintenance

### **IMPORTANT**

**Before any maintenance is started involving electrical parts, the appliance must be disconnected from the power supply.**

**If the oven has been in use, let the oven cavity and the heating elements cool down before attempting any maintenance.**

### **The oven exterior**

As the oven has a stainless steel or enamel surface, you should use a nonabrasive cleaner. Any abrasive cleaner (including Cif) will scratch the surface and could erase the control panel markings. Stainless steel can be effectively cleaned by simply using a dilute solution of water and mild detergent and drying to a shine with a clean cloth.

Proprietary stainless steel cleaners are available. We recommend the a clean microfibre cloth for cleaning stainless steel surfaces.

### **Inside of the oven**

The oven should always be cleaned after use when it has cooled down.

The cavity should be cleaned using a mild detergent solution and warm water.

Suitable proprietary chemical cleaners may be used after first consulting with the manufacturers' recommendations and testing a sample on a small area of the oven cavity. Abrasive cleaning agents or

scouring pads/cloths should not be used on the cavity surface.

**IMPORTANT:**

- **Steam cleaners must not be used when cleaning this appliance.**
- **Once care and maintenance is complete, ensure that all parts are correctly replaced before using the oven.**

## Changing the oven lamp

**Before any maintenance is started involving electrical parts, the appliance must be disconnected from the power supply.**

**If the oven has been in use, let the oven cavity and the heating elements cool down before attempting any maintenance.**

### Changing the bulb (fig. 2)

Unscrew the protective cover. We recommend that you wash and dry the glass cover at this point. Carefully remove the old bulb and insert the new bulb suitable for high temperatures (300°C) having the following specifications: 230-240V, 50Hz, 25W, G9 fitting.

Refit the protective cover.

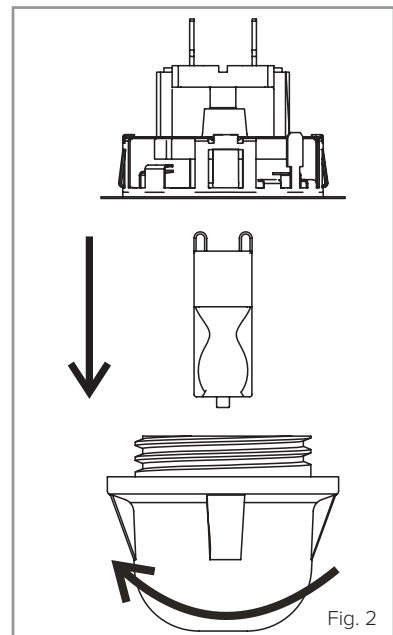

Fig. 2

---

## **IMPORTANT**

**Never use screwdrivers or other utensils to remove the light cover. This could damage the enamel of the oven or the lamp holder. Remove only by hand. Make sure the power is off and the lamp assembly has cooled.**

## **IMPORTANT**

**Never replace the bulb with bare hands as contamination from your fingers can cause premature failure. Always use a clean cloth or gloves.**

### **Please note:**

The bulb replacement is not covered by your guarantee.

See page 16 for information on removing the appliance doors.

# Oven doors

## Removing the oven doors

The oven door can easily be removed as follows:

- Open the door to the full extent (fig. 4).
- Open the lever A completely on the left and right hinges (fig. 5).
- Hold the door as shown in fig. 3.
- Gently close the door (fig. 6) until left and right hinge levers A are hooked to part B of the door (fig. 5).
- Withdraw the hinge hooks from their location following arrow C (fig. 7).
- Rest the door on a soft surface.
- To replace the door, repeat the above steps in reverse order.

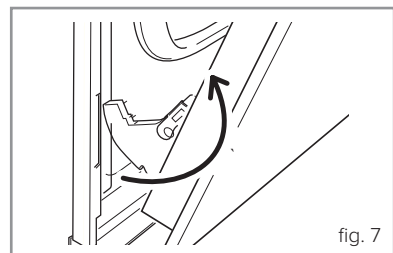
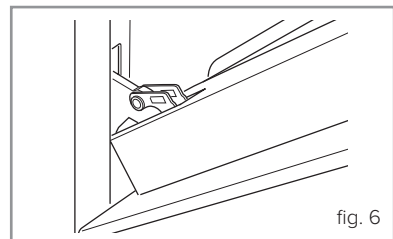
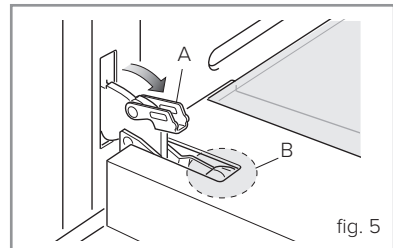
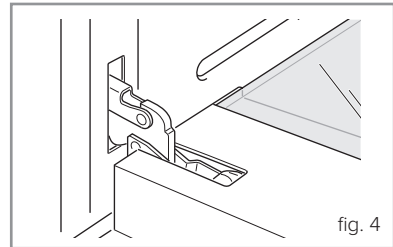
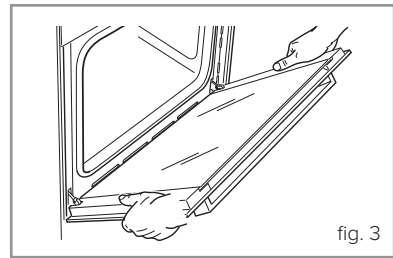



## Troubleshooting

If you have any problems with your appliance, you should check the following troubleshooting steps prior to calling CDA Customer Care to help avoid unnecessary service visits. Contact details for CDA Customer Care are on page 18 and the rear cover of this manual.

- **If there is no power to the oven.**

Check that the mains power supply is switched on. If it is and the oven is still not working then switch the mains power supply off and check the fuse at the spur. Replace the fuse and try switching the power back on.

- **If there is power to the oven (the programmer is on/lit) but the oven is not heating.**

It is possible that the current time/clock has not been set. Switch the appliance off at the mains power supply and then switch it back on. The clock should show '12:00' and a flashing rectangular indicator by the clock symbol on the control panel. Use the ⊕ or ⊖ keys to set the current time. After approximately 5 seconds the time should set and the oven should function as normal.

It is also possible that the automatic cooking function and a cooking duration have been engaged. This is signified by the end of cooking time indicator and the cooking time indicator being on. To cancel this function, press ok until the cooking time indicator flashes. Use ⊖ to return the cooking duration to '0.00'. After approximately 5 seconds you should be able to use your oven as normal.

---

- **If a function is on (and working) but the internal light is not working**

It is most likely that the bulb has blown. Switch the appliance off at the mains power supply and fit a replacement bulb as per page 14. Be sure to follow the safety warnings on page 14.

If none of the previous troubleshooting checks resolve your issue, please contact CDA Customer Care using the contact details below:

**Contact CDA Customer Care**

A : Customer Care Department, The CDA Group Ltd, Harby Road,  
Langar, Nottinghamshire, NG13 9HY

T : 01949 862 012

F : 01949 862 003

E : [customer.care@cda.eu](mailto:customer.care@cda.eu)

W : [www.cda.eu](http://www.cda.eu)

# Mains electricity connection

**Warning! This appliance must be earthed**

To connect this appliance to a UK standard mains supply, connect the bridging links between 1-2-3 for the live feed and 4-5 for the neutral feed.

This appliance must be connected to the power supply by a qualified electrician or engineer, who is a member of the N.I.C.E.I.C. and who will comply with the I.E.T. and local regulations.

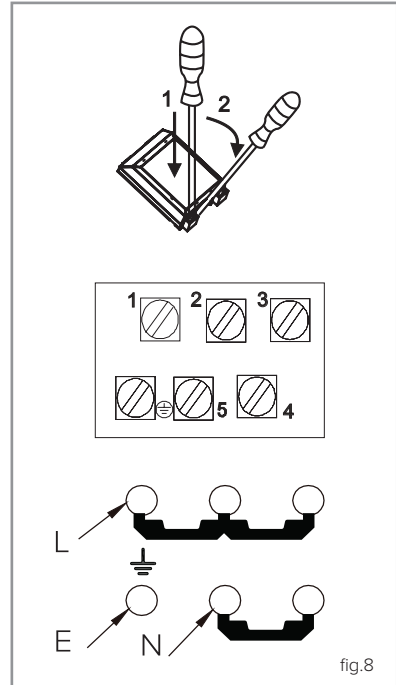

**This appliance is intended to be connected to fixed wiring and is not suitable for connection to a 13A plug or 13A supply.**

This appliance is intended to be connected to fixed wiring by a double pole switch, having a contact separation of at least 3mm in all poles. The switch must be positioned no further than 2m from the appliance.

Release the two locks located at either side of the connector cover at the rear of the appliance.

Feed the mains lead through the cable clamp to prevent accidental disconnection.

Tighten the cable clamp securely and close the connector cover.

**Green and Yellow = Earth (PE)**

**Blue = Neutral**

**Brown = Live**

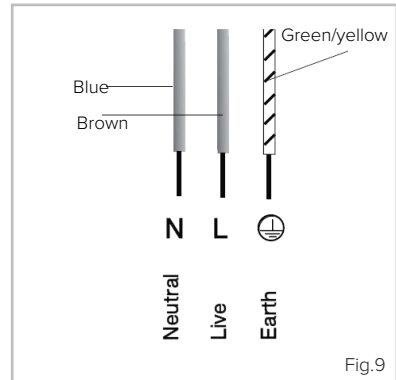

**Please note:**

- The mains cable must only be replaced by a qualified electrician or service engineer and must be of equivalent or better rating (i.e.  $2.5\text{mm}^2$ , HO5RR-F).
- This appliance is intended to be connected to the mains supply with a cable of cross section area  $2.5\text{mm}^2$ . A larger cable will not fit the terminal connections.
- The marking of the current rating of the fuse or circuit breaker protecting this appliance should be marked on the socket outlet.
- Assembly and electrical connection should be carried out by specialised personnel.
- When installing this product we recommend you seek the help of another individual.

# Installation

## **Important**

Failure to allow adequate ventilation to the appliance may result in overheating or damage to adjacent units and could invalidate the warranty. The diagram below shows the minimum required.

This appliance is type X installation. The walls of the kitchen units must be able to withstand temperatures of 75°C above ambient (typically this is between 90°C and 100°C).

When correctly installed ensure that there is a gap of 4mm minimum between the sides of the oven and adjacent furniture doors.

Lift the oven carefully into position on the shelf, taking care NOT to lift it by the door handles. If you lower the oven door, you will see 4 screw holes, 2 on each side of the oven. The oven should then be secured to the housing by fitting screws into these holes. Remember the housing should not be free standing but be secured to the wall and/or adjacent fittings.

## **How to install your oven**

You will need the following housing area fit your oven correctly.

DC741 only: We recommend that you fit end support panels onto the adjacent units to allow the oven to be secured in place (as shown in fig. 10).

If fitting a hob above your oven, observe the minimum gap required below the hob.

**DC741**

Dimensions	Oven	Housing
Height (mm)	718	720
Width (mm)	595	564
Depth (mm)	540	560 (min)

**DC941**

Dimensions	Oven	Housing
Height (mm)	890	877
Width (mm)	595	564
Depth (mm)	540	560 (min)

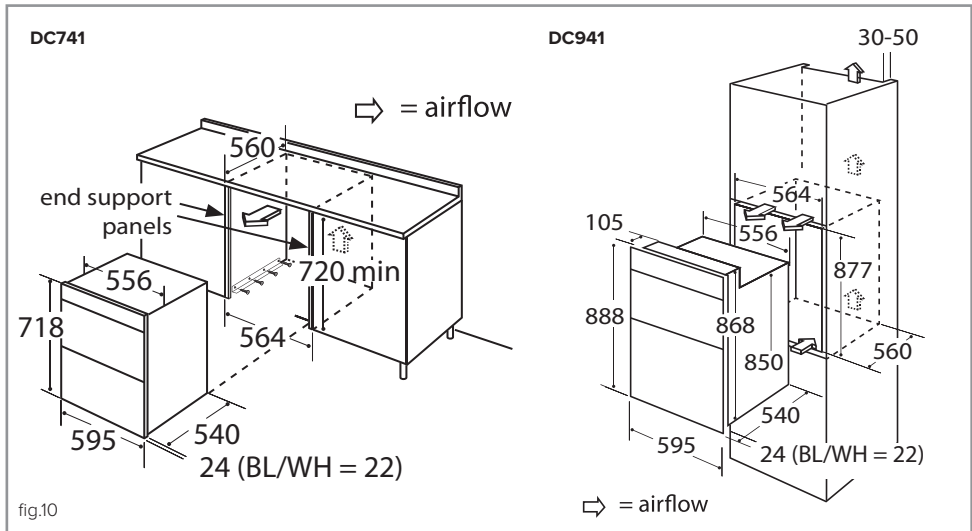

<b>Energy Efficiency Information</b>				
<b>Attribute</b>	<b>Symbol</b>	<b>Value</b>		<b>Units</b>
Model Identification		DC741	DC941	
Mass of the appliance	M	43.0	45.0	kg
Number of cavities		2	2	
Heat source per cavity (electricity or gas)		Electricity	Electricity	
Volume per cavity	V	Upper: 35 / Lower: 50	Upper: 35 / Lower: 59	L
Energy consumption (electricity) required to heat a standardised load in a cavity of an electric heated oven during a cycle in conventional mode per cavity (electric final energy)	EC <sub>Electric cavity</sub>	Upper: 0.60 / Lower: NA	Upper: 0.66 / Lower: NA	kWh/cycle
Energy consumption (electricity) required to heat a standardised load in a cavity of an electric heated oven during a cycle in fan-forced mode per cavity (electric final energy)	EC <sub>Electric cavity</sub>	Upper: NA / Lower: 0.66	Upper: NA / Lower: 0.75	kWh/cycle
Energy consumption required to heat a standardised load in a gas-fired cavity of an oven during a cycle in conventional mode per cavity (gas final energy)	EC <sub>Gas cavity</sub>	NA	NA	MJ/cycle : kWh/cycle
Energy consumption required to heat a standardised load in a gas-fired cavity of an oven during a cycle in fan-forced mode per cavity (gas final energy)	EC <sub>Gas cavity</sub>	NA	NA	MJ/cycle : kWh/cycle

E & O E. All instructions, dimensions and illustrations are provided for guidance only. CDA reserve the right to change specifications without prior notice.



**For service or queries relating to your product please contact:**

The Customer Care Department on **01949 862 012** or email [customer.care@cda.eu](mailto:customer.care@cda.eu)

**For more information please contact:**

The Sales Department on **01949 862 010** or email [sales@cda.eu](mailto:sales@cda.eu)

**Customer Care Department.** The CDA Group Ltd, Harby Road, Langar, Nottinghamshire, NG13 9HY  
**T:** 01949 862 012 **F:** 01949 862 003 **E:** [customer.care@cda.eu](mailto:customer.care@cda.eu)