

SK110, SK210 & SK310 Single Ovens

Installation, Use and Maintenance



Important

This appliance must only be used for the purpose for which it is intended, i.e. domestic cooking. Any other use could be dangerous and may lead to premature failure of the appliance.

The CDA Group Ltd cannot be held responsible for injuries or losses caused by incorrect use or installation of this product. Please note that CDA reserve the right to invalidate the guarantee supplied with this product following incorrect installation or misuse of the appliance.

Under no circumstances should any external covers be removed for servicing or maintenance except by suitably qualified personnel.

User information:

- Ovens become hot during and immediately after use.
- The oven door can become very hot during operation.
- After use, please ensure that the oven switches are in the 'Off' position.
- Keep children away from the appliance when in use, and immediately after use.
- Keep the oven door closed whilst grilling.

Appliance information:

Please enter the details on the appliance rating plate below for reference, to assist CDA Customer Care in the event of a fault with your appliance and to register your appliance for guarantee purposes.

Appliance Model	
-----------------	--

Serial Number	
---------------	--

CE Declarations of Conformity:

This oven has been designed, constructed and marketed in compliance with safety requirements of EEC Directive 2006/95/EEC (Low voltage) and requirements of EMC Directive 2004/108/EEC.

This appliance has been manufactured to the strictest standards and complies with all applicable legislation, including Electrical safety (LVD) and Electromagnetic interference compatibility (EMC). Parts intended to come into contact with food conform to EEC/89/109.4

IMPORTANT INFORMATION FOR CORRECT DISPOSAL OF THE PRODUCT IN ACCORDANCE WITH EC DIRECTIVE 2002/96/EC.

At the end of its working life, the product must not be disposed of as urban waste. It must be taken to a special local authority differentiated waste collection centre or to a dealer providing this service.

Disposing of a household appliance separately avoids possible negative consequences for the environment and health deriving from inappropriate disposal and enables the constituent materials to be recovered to obtain significant savings in energy and resources. As a reminder of the need to dispose of household appliances separately, the product is marked with a crossed-out wheeled dustbin. 

Important

- Read the user instructions carefully before using the oven for the first time.
- Follow the instructions for first use of the oven.
- Clean the oven regularly.
- Remove spills as soon as they occur.
- Always use oven gloves when removing shelves and trays from the ovens.
- Do not allow children near the oven when in use.
- Do not allow fat or oils to build up on the oven shelves, grill pan or oven base.
- Do not place any cooking utensils or plates directly on the oven base.
- Always grill with the oven door closed.
- Do not grill food containing fat without using the grill pan grid.
- Do not cover the grill pan grid or the oven walls with aluminium foil.
- Do not use the oven tray for roasting.
- Do not perform maintenance or cleaning of the oven without first switching off the electricity supply. If the oven has recently been used, allow to cool.
- Do not place hot enamel parts in water. Leave them to cool first.
- Do not allow vinegar, coffee, milk, saltwater, lemon or tomato juice to remain in contact with enamel parts.
- Do not use abrasive cleaners or powders that will scratch the surface of the enamel.

- Do not attempt to repair the internal workings of your oven.
- Do not cover the oven floor with aluminium foil.

First Use of the Oven

First use

- The decorative metal finish of this appliance has been coated with a preservative to protect it during transport and storage. This should be removed during installation by using a non-abrasive stainless steel cleaner, and dried thoroughly afterwards. Always follow the instructions given with the cleaner being used.
- Before using the oven for the first time we recommend that you clean the oven with soapy water, rinse carefully and then heat on each of the below programmes at maximum temperature for the specified time. A slightly unpleasant smell may be produced, caused by grease remaining on the oven elements from the production process.

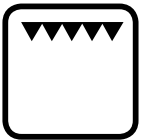

15 minutes grill.



60 minutes fan oven.



60 minutes conventional oven (SK310 only)

Please note:

- This oven has been fitted with a cooling fan to achieve maximum efficiency and to maintain low surface temperatures. The cooling fan will switch on automatically when the oven switches on. It is normal for the cooling fan to run for an hour or more after use, depending on the duration, temperature and type of cooking programme used.
- The oven light remains on for every cooking function.
- Do not switch off the oven if you have set a programme for semi-automatic or automatic cooking as this will cancel the programme.

Oven Controls and Use

Temperature knob

- To set the temperature, turn the temperature knob clockwise to the required temperature.
- Once the oven has reached the required temperature, the temperature indicator lamp on the control panel will switch off.
- The temperature indicator lamp will light up when the oven elements are in operation.

Cooking function knob

To set the function, turn the cooking function knob to the required function.

Each of the oven functions uses different elements within the oven to offer you the best choice of cooking every time. These are explained below:

Please note, the oven light will operate on all functions.

Internal shelf positions

The shelves and grill pan can be inserted into any one of six different positions.

To refer to these they are numbered from “1” to “6”, with “1” nearest the grill elements at the top of the oven. Printing on the inside of the oven door is designed to remind you of this numbering (Fig. 1).

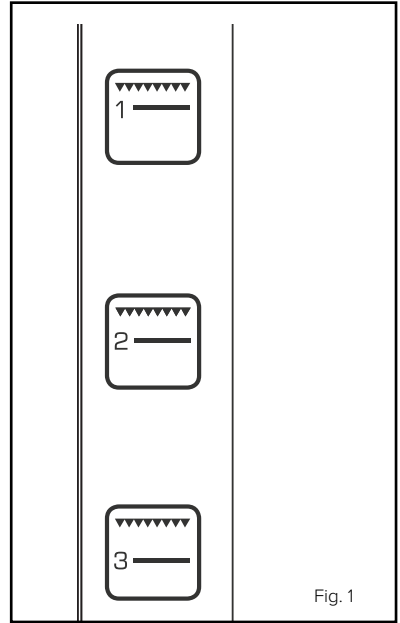

SK110 & SK210



Defrost (Shelf position 3, 4 or 5)

Using the fan only this oven function circulates the air around the oven cavity, speeding up the natural defrost process (1kg takes approximately one hour, depending on the type of food).



Fan Oven (Shelf position 4 or 5)

Using the circular element and the fan with a temperature between 50°C and 250°C, this cooking function blows the air into and around the oven cavity. Temperatures are achieved quicker, reducing or even removing the need for preheating. Both cooking temperatures and cooking times can be reduced for a more energy efficient cooking programme.



Fanned Grill (Grill pan position 1, 2 or 3)

This function uses the fan to circulate the heat from the grill element around the food.

The temperature can be set between 50°C and 250°C.



Full Grill (Grill pan position 1, 2 or 3)

This function radiates the heat from the grill element.

This fully temperature variable grill is ideal for grilling a full family meal. It can be set between 50°C and 250°C maximum.

For each grill function please note:

- Always grill with the oven door closed.
- Put the grill pan as close to the grill as possible.
- Do not grill for more than 30 minutes at a time.
- Preheat the grill for up to five minutes with the oven door closed.

SK310



Defrost (Shelf position 3, 4 or 5)

Using the fan only this oven function circulates the air around the oven cavity, speeding up the natural defrost process (1kg takes approximately one hour, depending on the type of food).



Fan Oven (Shelf position 4 or 5)

Using the circular element and the fan with a temperature between 50°C and 250°C, this cooking function blows the air into and around the oven cavity. Temperatures are achieved quicker, reducing or even removing the need for preheating. Both cooking temperatures and cooking times can be reduced for a more energy efficient cooking programme.



Fanned Grill (Grill pan position 1, 2 or 3)

This function uses the fan to circulate the heat from the grill element around the food.

The temperature can be set between 50°C and 250°C.

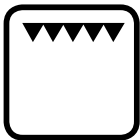

Full Grill (Grill pan position 1, 2 or 3)

This function radiates the heat from the grill element and the top element.

This fully temperature variable grill is ideal for grilling a full family meal. It can be set between 50°C and 250°C maximum.

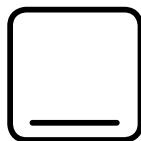

Warming Oven (Shelf position 5 or 6)

Using heat produced only by the bottom element, this natural heat is perfect for dough proving and blind-baking.



Fan Assisted Oven (Shelf position 3, 4 or 5)

Using the circular element and the fan with a temperature between 50°C and 225°C, this cooking function blows the air into and around the oven cavity. Temperatures are achieved quicker, reducing or even removing the need for preheating. Both cooking temperatures and cooking times can be reduced for a more energy efficient cooking programme.



Conventional Oven (Shelf position 4 or 5)

This function uses the upper and lower heating elements with a temperature between 50°C and 240°C.

Natural convection creates a perfect cooking zone in the centre of the oven, ideal for dark fruit cakes and pastries.

For each grill function please note:



- Always grill with the oven door closed.
- Put the grill pan as close to the grill as possible.
- Do not grill for more than 30 minutes at a time.
- Preheat the grill for up to five minutes with the oven door closed.



Programming the Oven (SK210 & SK310 Only)

Please note:

- The alert beep will cut off after two minutes if it is not switched off manually.

Setting the clock

The clock is preset to 12:00, and will revert to this after a power failure. When the current time indicator is flashing, touch  or . When the correct time is shown on the display, the clock will set after approximately five seconds delay.



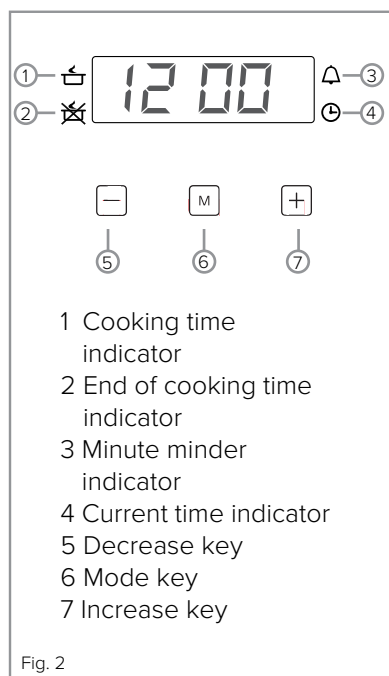

To change the clock once it has been set, touch  repeatedly until the current time indicator flashes, then touch  or . When the correct time is shown on the display, the clock will set after approximately five seconds delay.

The minute minder

The minute minder can be used when the oven is switched on or off. It can be set for up to 23 hours and 59 minutes.



To set the minute minder:

- Touch  repeatedly until the minute minder indicator flashes.
- Then touch  or  to select the required duration for the minute minder. When the correct duration shows on the display, either touch  or wait for approximately five seconds. The minute minder indicator will remain lit to confirm the minute minder is on.
- When the countdown is complete, there will be an alert beep which will continue for two minutes and the minute minder indicator will flash. To switch off the alert beep, touch any key.

Please note:

At the end of the countdown, the minute minder will not switch off the oven. Remember to turn off the oven manually.

Semi-automatic cooking

The oven can be set to switch off automatically at a preset time up to a maximum of 10 hours.

To set a semi-automatic cooking programme:

- Select the oven function and temperature (the oven will switch on).
- Touch **M** until the cooking time indicator flashes.
- Then touch **-** or **+** to select the required duration for the semi-automatic cooking programme. When the correct duration shows on the display, wait for approximately five seconds. The cooking time indicator will remain lit to confirm the semi-automatic programme is on.
- When the cooking time is complete, there will be an alert beep which will continue for two minutes and the cooking time indicator will flash. To switch off the alert beep, touch any key.

Please note:

At the end of the cooking programme, remember to turn off the oven manually.

Automatic cooking

The main oven can be set to switch on and off automatically at preset times up to a maximum of 10 hours.

To set an automatic cooking programme, follow the steps for setting a semi-automatic programme above, and then:

- Touch **M** until the end of cooking time indicator flashes.
- Then touch **-** or **+** to select the required end of cooking time. When the correct time shows on the display, wait for approximately five

seconds. The cooking time and end of cooking time indicators will remain lit to confirm the automatic programme is on.

- The oven will switch off until the automatic programme starts. When the programme starts, the cooking time indicator will switch off
- When the cooking time is complete, there will be an alert beep which will continue for two minutes and the end of cooking time indicator will flash. To switch off the alert beep, touch any key.

Please note:

At the end of the cooking programme, remember to turn off the oven manually.

IMPORTANT:

When correctly installed, your product meets all safety requirements laid down for this type of product. However, special care should be taken around the rear or the underneath of the appliance as these areas are not designed or intended to be touched and may contain sharp or rough edges that could cause injury.

Care and Maintenance

IMPORTANT

- **Before any maintenance is started involving electrical parts, the appliance must be disconnected from the power supply.**
- **If the oven has been in use, let the oven cavity and the heating elements cool down before attempting any maintenance.**
- **Steam cleaners must not be used when cleaning this appliance.**
- **Once care and maintenance is complete, ensure that all parts are correctly replaced before using the oven.**

The oven exterior

As the oven has a stainless steel or enamel surface, you should use a nonabrasive cleaner. Any abrasive cleaner (including Cif) will scratch the surface and could erase the control panel markings. Stainless steel can be effectively cleaned by simply using a dilute solution of water and mild detergent and drying to a shine with a clean cloth.

Proprietary stainless steel cleaners are available. We recommend the CDA E-Cloth available from the CDA Sales Team for cleaning stainless steel surfaces as this has been designed to prolong the finish of your appliance.

Inside of Oven

The oven should always be cleaned after use when it has cooled down.

The cavity should be cleaned using a mild detergent solution and warm water.

Suitable proprietary chemical cleaners may be used after first consulting with the manufacturer's recommendations and testing a sample on a small area of the oven cavity. Abrasive cleaning agents or scouring pads/cloths should not be used on the cavity surface.

Oven door glass

As the oven door is double glazed, the inner glass may be removed for cleaning both the inner glass and the inside face of the outer glass.

You may find it easier to remove the complete door to dismantle the glass but it is not essential to do so: Door removal is explained on the next page.

To remove the inner glass

- Remove both door top corner pieces; these can be removed by pressing the buttons shown at "A" in fig. 3, then sliding the corner pieces toward you.
- Lift the edge of the glass nearest to you slightly then slide it from its lower clips.
- After cleaning the glass, replacement is a reversal of the removal process.
- Take care to assemble the glass the right way around, the printed surface must be visible when the door is opened.

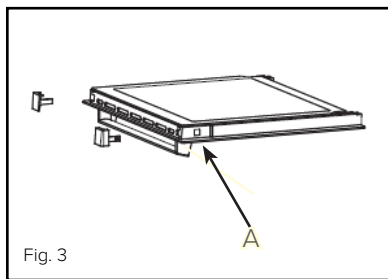

Fig. 3

Oven Door

Removing the Oven Door

The oven door can easily be removed as follows:

- Open the door to the full extent (Fig. 4).
- Open the lever A completely on the left and right hinges (Fig. 5).
- Hold the door as shown (Fig. 8).
- Gently close the door (Fig. 6) until left and right hinge levers A are hooked to part B of the door (Fig. 5).
- Withdraw the hinge hooks from their location following arrow C (Fig. 7).
- Rest the door on a soft surface.
- To replace the door, repeat the above steps in reverse order.

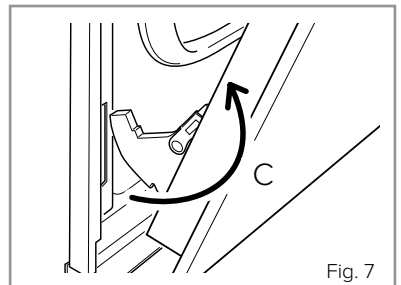
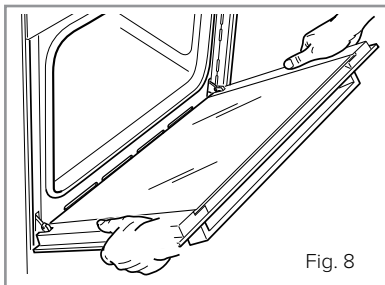
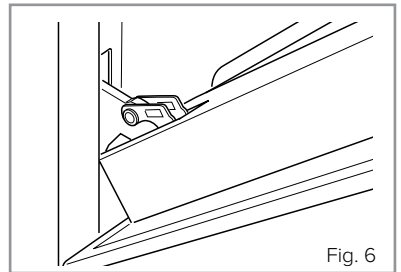
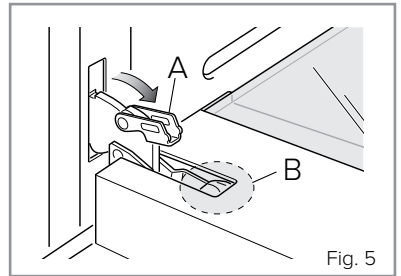
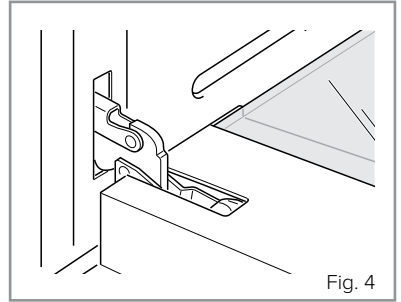

Changing the bulb - Lateral lights (SK310 Only)

- Remove all shelves and the grill pan from the oven.
- Gently unclip the side rack from its lower locating stud and unhook its top to remove it.

Note: No tools are required and the stud should not be removed.

- Carefully detach the glass cover from the lamp holder, by sliding it upward then easing the bottom outward.
- Carefully remove the old bulb and insert a new bulb, suitable for high temperatures (300°C) having the following specifications: 230-240V, 50Hz, 25W, G9 fitting.
- Insert the new bulb taking care not to touch the glass with your hands as contamination from your fingers can cause premature failure. Always use a clean cloth or gloves.
- Reattach the glass cover, pressing it firmly into position.
- Replace the side rack by locating the two hooks at the top and clipping it back into position on its lower fixing stud.
- Replace the oven shelves and grill pan as necessary.

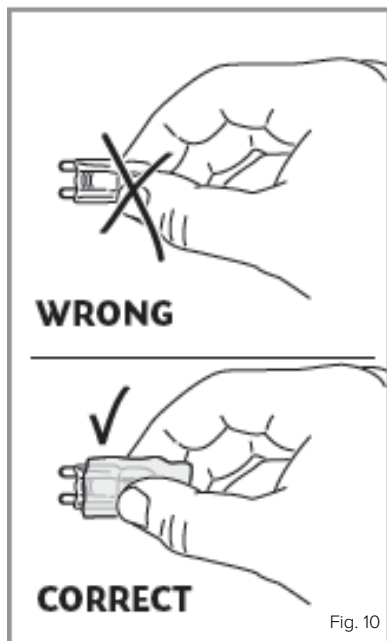
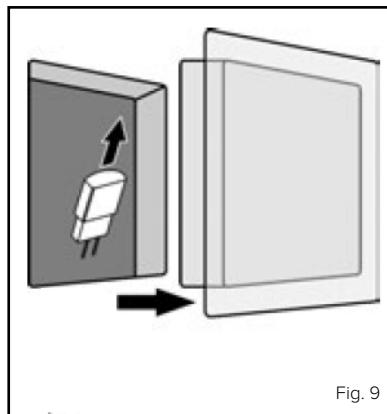

Changing the bulb - Back light (SK110 & SK210 Only)

Unscrew the protective cover. We recommend that you wash and dry the glass cover at this point.

Carefully remove the old bulb and insert the new bulb suitable for high temperatures (300°C) having the following specifications: 230-240V, 50Hz, 25W, G9 fitting.

Refit the protective cover.

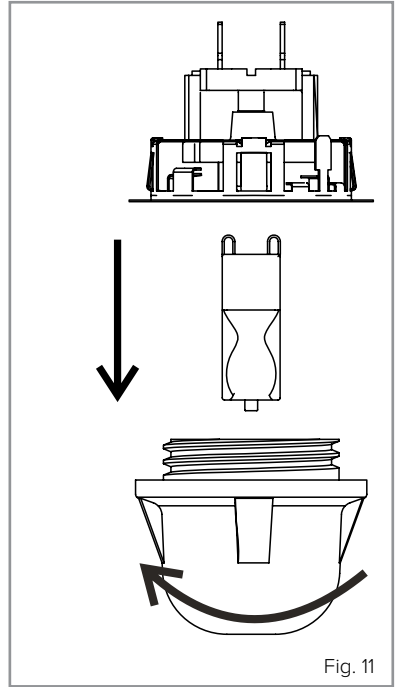

Fig. 11

IMPORTANT

- **Never use screwdrivers or other utensils to remove the light cover. This could damage the enamel of the oven or the lamp holder. Remove only by hand.**
- **Never replace the bulb with bare hands as contamination from your fingers can cause premature failure. Always use a clean cloth or gloves.**

Please note:

The bulb replacement is not covered by your guarantee.

Installation

Important

If the oven is being installed into a built under oven housing unit ensure that the front rail at the top of the unit is not installed as it could restrict ventilation.

Ensure that air can flow freely around the housing area. If the oven is being installed into a fully enclosed built-under oven housing unit it may be necessary to cut a small slot in the top of the plinth fitted under the unit. Cut a section 400mm wide and a minimum of 15mm high to allow air to pass under the unit. Alternatively cut a section 400 x 450mm in the base of the carcass as indicated.

Failure to allow adequate ventilation to the appliance may result in overheating or damage to adjacent units and could invalidate the warranty.

This appliance is type X installation.

The walls of the kitchen units must be able to withstand temperatures of 75°C above ambient (typically this is between 90°C and 100°C).

When correctly installed ensure that there is a gap of 4mm minimum between the sides of the oven and adjacent furniture doors.

Lift the oven carefully into position on the shelf, taking care NOT to lift it by the door handle. If you lower the oven door, you will see 4 screw holes, 2 on each side of the oven. The oven should then be secured to the housing by fitting screws into these holes. Remember the

housing should not be free standing but be secured to the wall and/or adjacent fittings.

How to install your oven

You will need the following housing area to fit your oven correctly.

The oven is designed to fit into a cabinet of 600mm width. The oven can be built in or built under the kitchen units, but you must ensure that it is properly ventilated. In the diagram the built-in oven is ventilated by means of a space at the top of the kitchen cabinet. There are many other methods of ventilating your oven - consult a qualified engineer for advice.

Dimensions	Oven	Housing
Height (mm)	595	600
Width (mm)	595	560
Depth (mm)	567	560 (min)

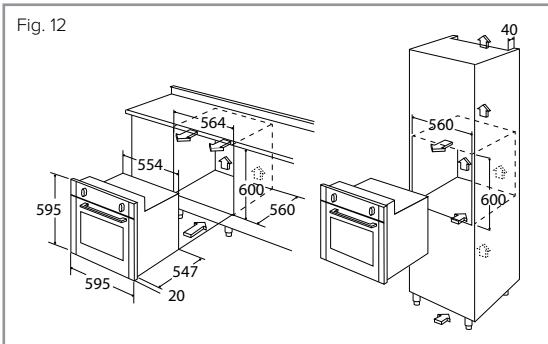

Electricity Supply to Your Oven

Warning! this appliance must be earthed.

This appliance must be connected by a competent person, using fixed wiring via a double pole switched fused spur outlet, protected by a 13A fuse.

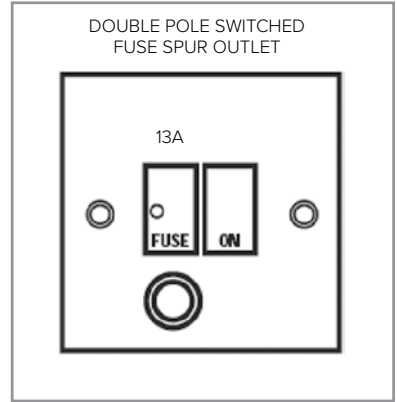

We recommend that the appliance is connected by a qualified electrician, who is a member of the N.I.C.E.I.C. and who will comply with the I.E.T. and local regulations. The wires in the mains lead are coloured in accordance with the following code:

GREEN AND YELLOW = EARTH BLUE = NEUTRAL BROWN = LIVE.

As the colours of the wires in the mains lead for the appliance may not correspond with the coloured markings identifying the terminals in your spur box, proceed as follows:

1. The wire which is coloured green and yellow must be connected to the terminal marked E (Earth) or coloured Green.
2. The wire which is coloured blue must be connected to the terminal marked N (Neutral) or coloured Black.
3. The wire which is coloured brown must be connected to the terminal marked L (Live) or coloured Red.

Energy Efficiency Information

Attribute	Symbol	Value		Units
Model identification		SK110/SK210	SK310	
Mass of the appliance	M	34	34	kg
Number of cavities		1	1	
Heat source per cavity (electricity or gas)		Electricity	Electricity	
Volume per cavity	V	74.0	74.0	L
Energy consumption (electricity) required to heat a standardised load in a cavity of an electric heated oven during a cycle in conventional mode per cavity (electric final energy)	$EC_{\text{Electric cavity}}$	NA	0.81	kWh/cycle
Energy consumption (electricity) required to heat a standardised load in a cavity of an electric heated oven during a cycle in fan-forced mode per cavity (electric final energy)	$EC_{\text{Electric cavity}}$	0.68	0.68	kWh/cycle
Energy consumption required to heat a standardised load in a gas-fired cavity of an oven during a cycle in conventional mode per cavity (gas final energy)	$EC_{\text{Gas cavity}}$	NA	NA	MJ/cycle : kWh/cycle
Energy consumption required to heat a standardised load in a gas-fired cavity of an oven during a cycle in fan-forced mode per cavity (gas final energy)	$EC_{\text{Gas cavity}}$	NA	NA	MJ/cycle : kWh/cycle

E & O E. All instructions, dimensions and illustrations are provided for guidance only. CDA reserve the right to change specifications without prior notice.



Please contact our **Customer Care Department** for Service on the details below

Customer Care Department

The ICDAI Group Ltd. • Harby Road • Langar • Nottinghamshire • NG13 9HY
T : 01949 862 012 F : 01949 862 003 E : customer.care@cda.eu

