



User manual  
Heat-Pump-Dryer

HD80-A2939

HD80-A2939S

HD90-A2939

HD90-A2939S

HD100-A2939

HD100-A2939S

HD90-A3939

HD90-A3939S

EN

**Haier**

## Thank you for purchasing a Haier Product.

Please read this instruction carefully before using the appliance. The instruction contains important information which will guide you in order to have a safe and proper installation as well as daily use and maintenance.

Keep this manual in a convenient place so you can always refer to it for the safe and proper use of the appliance.

### Safety notice



**Warning!** – Important safety information



General information and tips



Environmental information

### Disposal



This marking on the product, accessories or literature indicates that the product and its electronic accessories (e.g. charger, (e.g. charger, headset, USB cable) should not be disposed of with other household waste at the end of their working life.

To prevent possible harm to the environment or human health from uncontrolled waste disposal, please separate these items from other types of waste and recycle them responsibly to promote the sustainable reuse of material resources. Household users should contact either the retailer where they purchased this product, or their local government office, for details of where and how they can take these items for environmentally safe recycling. Business users should contact their supplier and check the terms and conditions of the purchase contract. This product and its electronic accessories should not be mixed with other commercial wastes for disposal.



### **WARNING!**

#### **Risk of injury or suffocation!**

Disconnect the appliance from the power supply. To ensure safety when disposing of an old tumble dryer disconnect the mains plug from the socket, cut the mains power cable and destroy this together with the plug. To prevent children shutting themselves in the machine break the door hinges or the door lock.



### **WARNING!**

The appliance must not be powered through an external switching device, such as a timer, or connected to a circuit that is regularly switched on and off by a utility.

Safety information .....	4
Installation pictures .....	7
Intended use.....	8
Product description.....	9
Control panel.....	10
Programs.....	13
Consumption .....	14
Suggestions and tips.....	15
Daily use.....	17
Care and cleaning.....	21
Troubleshooting .....	24
Installation.....	25
Technical data .....	28
Customer Service .....	30



## WARNING!

### Before first use

- ▶ Make sure there is no transportation damage.
- ▶ Remove all package and keep it out of children's reach.
- ▶ Always move the appliance with two people at least because it is heavy.

### Daily use

- ▶ This appliance can be used by children aged from 8 years and above and persons with reduced physical, sensory or mental capabilities or lack of experience and knowledge if they have been given supervision or instruction concerning use of the appliance in a safe way and understand the hazards involved.
- ▶ Keep away children under 3 years of age from the appliance unless they are constantly supervised.
- ▶ Children shall not play with the appliance.
- ▶ Do make sure the room is dry and well ventilated. The ambient temperature should be between 5 °C and 35 °C.
- ▶ Do not cover any ventilation openings in the base by a carpet or similar object.
- ▶ Keep the area around the tumble dryer free of dust and lint.
- ▶ Do make sure that there is only laundry inside the appliance and no pets or children before you use it.
- ▶ Only touch the mains plug with dry hands and do not touch or use the appliance if you are barefoot or with wet hands or feet
- ▶ Do not dry unwashed items in the tumble dryer.
- ▶ Do make sure not to load more than nominal load.
- ▶ Remove all items such as lighters and matches from pockets.
- ▶ Fabric softeners, or similar products, should be used as specified by the fabric softener instructions.
- ▶ Do not use or store any flammable sprays or flammable gas in close vicinity to the appliance.
- ▶ Do not place heavy objects or sources of heat or damp on top of the appliance.
- ▶ Hold the plug, not the cable, when unplugging the appliance.
- ▶ Do not touch the rear and the drum during operation, they are hot.

**WARNING!****Daily use**

- ▶ Do not use the appliance to dry following items
  - ▶ Items which are not washed.
  - ▶ Items which have been contaminated with inflammable substances such as cooking oil, acetone, alcohol, benzine, petrol, kerosene, spot removers, turpentine, waxes, wax removers or other chemicals. The fumes can cause a fire or explosion. Items that have been soiled with substances such as cooking oil, acetone, alcohol, petrol, kerosene, spot removers, turpentine, waxes and wax removers should be washed in hot water with an extra amount of detergent before being dried in the tumble dryer.
  - ▶ Items which contain padding or fillings (e.g. pillows, jackets), as the filling can get out with the risk of causing ignition.
  - ▶ Items such as foam rubber (latex foam) shower caps, water-proof textiles, rubber backed articles and clothes or pillows pillows fitted with foam rubber pads should not be dried in the tumble dryer.
- ▶ Do not drink the condensed water.
- ▶ Do not use the appliance without the lint filter or condenser filter in place or with damaged filter.
- ▶ Notice that the last part of the drying cycle occurs without heat (cool down cycle) to ensure remaining garments are under a temperature which does not damage them.
- ▶ Do not leave the appliance unattended during run time for a long time. If a long absence is needed, the drying cycle have to be interrupted by switching off and unplugging the mains.
- ▶ Do not switch off the appliance until drying cycle is finished, Never stop a tumble dryer before the end of the drying cycle unless all items are quickly removed and spread out so that the heat is dissipated.
- ▶ Switch off the appliance after each drying programme to save electricity and for safety.

**Maintenance / cleaning**

- ▶ Make sure children are supervised if they carry out cleaning and maintenance.
- ▶ Disconnect the appliance from the electrical supply before undertaking any routine maintenance.



## WARNING!

### Maintenance / cleaning

- ▶ Clean the lint filter and the condenser filter after each programme (see CARE AND CLEANING).
- ▶ Do not use water spray or steam to clean the appliance.
- ▶ Do not use industrial chemicals to clean the appliance.
- ▶ If the supply cord is damaged, it must be replaced by the manufacturer, its service agent or similarly qualified persons in order to avoid a hazard.
- ▶ Do not try to repair the appliance by yourself. If a repair is needed, please contact our customer service.

### Installation

- ▶ Ensure put the machine in a place which allows opening the door fully. Do not install the tumble dryer behind a lockable door, a sliding door or a door with hinges on the opposite side of the tumble dryer door as this limits the full opening of the door.
- ▶ Install the appliance in a well-ventilated, dry place.
- ▶ Never install the appliance in a damp outdoor, or in an area which has the risk of water leakage such as under or near a sink unit. Once a water leakage happened, cut power supply and allow the machine to dry naturally.
- ▶ Install or use the appliance only in a place where the temperature is above 5 °C.
- ▶ Do not place the appliance directly on a carpet, or close to a wall or furniture.
- ▶ Do not expose the appliance to any frost, heat or direct sunlight or around any heat sources (e.g. stoves, heaters).
- ▶ Make sure that the electrical information on the rating plate aligns with the power supply. If it does not, contact an electrician.
- ▶ Do not use multi-plug adapters and extension cables.
- ▶ Make sure not to damage the electric cable and the plug. If it is damaged, have it replaced by an electrician.
- ▶ Use a separate earthed socket for the power supply which is easy access to after installation. The appliance must be earthed.
- ▶ Only for UK: The appliance's power cable is fitted with 3-cord (grounding) plug that fits a standard 3-cord (grounded) socket. Never cut off or dismount the third pin (grounding). After the appliance is installed, the plug should be accessible.

# 2-Installation pictures

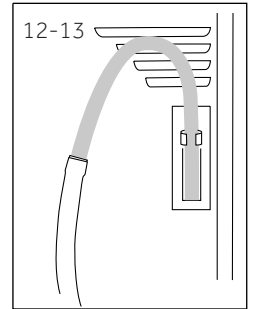
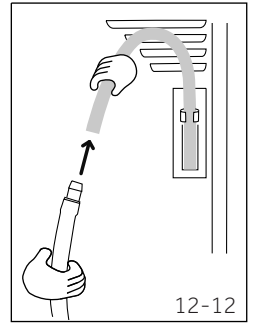
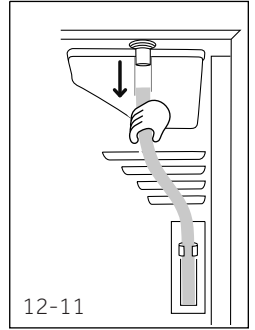
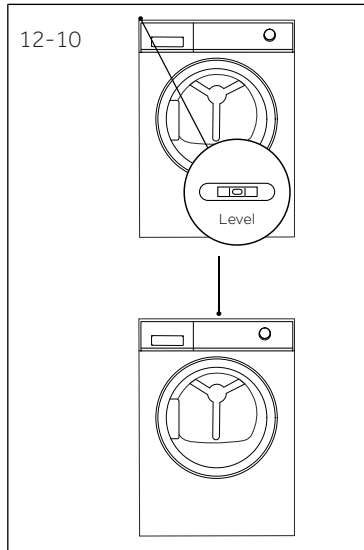
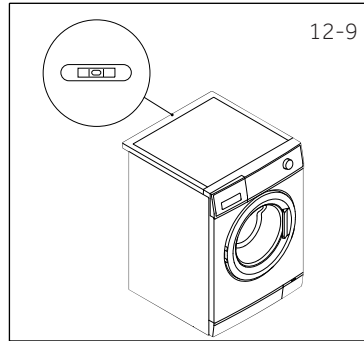
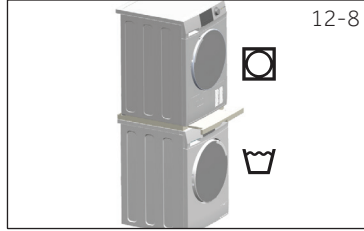
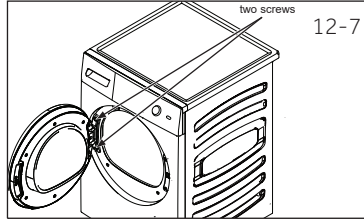
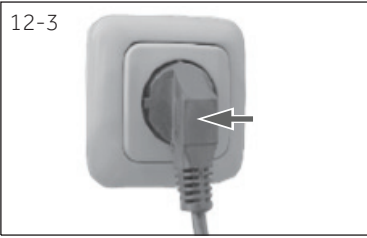
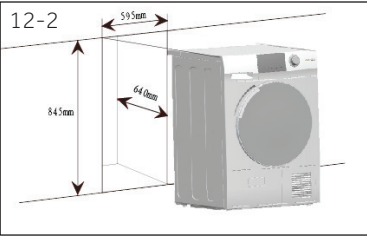

## Intended use

This appliance is intended for drying items which have been washed in a water solution and are marked on the manufacturer's care label as being suitable for tumble drying.

It is designed exclusively for domestic use inside the house. It is not intended for commercial or industrial use. Changes or modifications to the device are not allowed. Unintended use may cause hazards and loss of all warranty and liability claims.

## Standards and directives

This product meets the requirements of all applicable EC directives with the corresponding harmonised standards, which provide for CE marking.



### Notice

The appliance contains the fluorinated greenhouse gas R134a (GWP:1430). This gas is hermetically sealed.



### Environmentally responsible use

- ▶ **Completely spin:** Spin the laundry with the maximum spin speed.
- ▶ **Maximum load:** Use the maximum filling amount according to the programme table, but do not overload the dryer. To take advantage of the maximum load, the laundry which should be dried "READY to wear", can be first dried easily with "Ironing". When program ends, remove the laundry which should be ironed and dry the remaining laundry then to end.
- ▶ **Loosen up the laundry:** Shake out the laundry before putting them into the dryer.
- ▶ **Avoid excess drying:** An excessive drying should be avoided. Select the right programme and the appropriate dry level.
- ▶ **Softener unnecessary:** Do not use softener when washing, because the laundry will become fluffy and soft in the dryer .
- ▶ **Cleaning of the lint filters:** Clean the lint filters after each cycle.
- ▶ **Ventilation:** Make sure the appliance is properly ventilated (see INSTALLATION).
- ▶ **Condensed water reuse:** The collected condensed water can be used for the steam iron. Before that, it should be poured through a fine sieve or coffee filter paper, Smallest parts will be retained by the filter.



**i Note:**

Due to technical changes and different models, the illustrations in the following chapters may differ from your model.

#### 4.1 Picture of appliance

Front (Fig. 4-1):

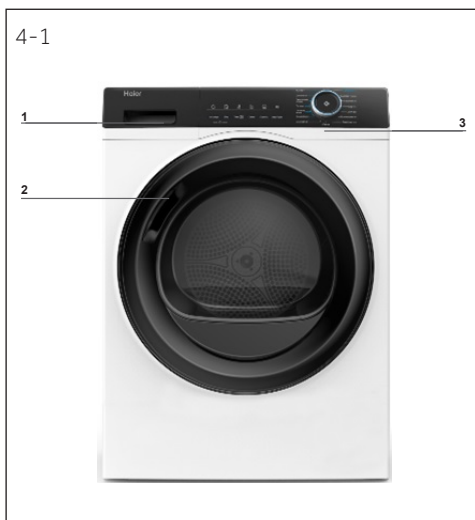

- 1 Water tank
- 2 Tumble dryer door
- 3 Control panel

Rear side (Fig. 4-2):

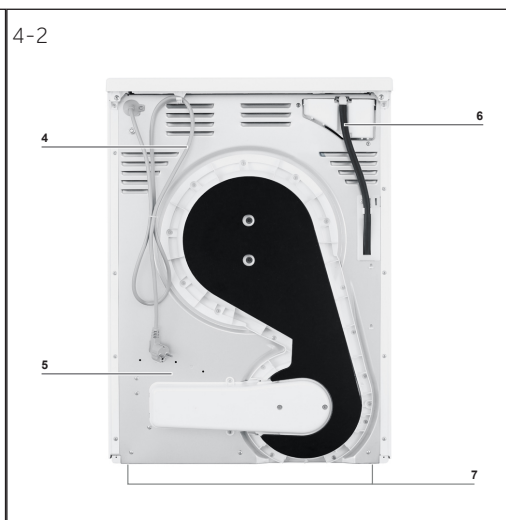

- 4 Power supply cord
- 5 Back plate
- 6 Drainage outlet
- 7 Adjustable feet

#### 4.2 Accessories

Check the accessories and literature in accordance with this list (Fig.4-3):

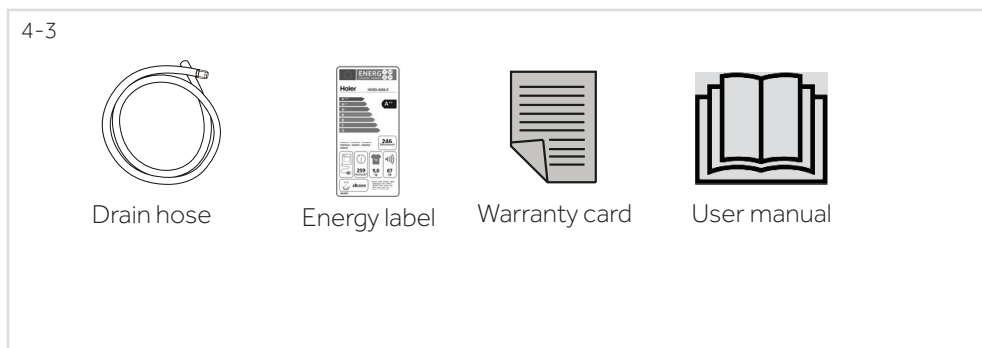

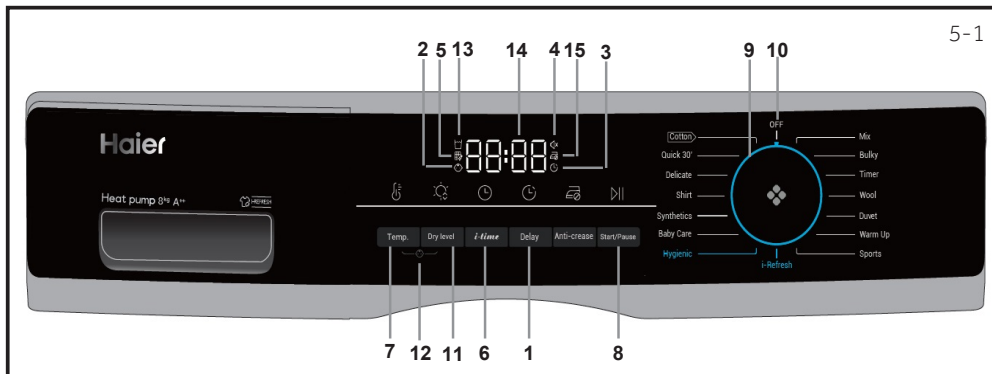

5-1

- |                          |                      |                          |
|--------------------------|----------------------|--------------------------|
| 1 Delay button           | 7 Temp. button       | 13 Empty tank indicator  |
| 2 Child-lock indicator   | 8 Start/Pause button | 14 Display               |
| 3 Delay indicator        | 9 Program knob       | 15 Anti-crease indicator |
| 4 Buzzer indicator       | 10 Power             |                          |
| 5 Clean filter indicator | 11 Dry level button  |                          |
| 6 Time button            | 12 Childlock button  |                          |

## 5.1 Delay button

Delay function allows users to delay the start time of the cycle. Press the button (Fig.5-2) to set the desired starting time (From 0 up to 12 hours). When activating, the indicator icon (Fig.5-4) will light up.



5-2

### Notice

This function should be set after you have finished all the options, otherwise when you turn the knob or press the button, the function will be cancelled automatically.

## 5.2 Child lock indicator

Child lock is designed to prevent children from adjusting the program setting. To activate this function, after a cycle has been started, press the Dry level and Temp. button (Fig.5-3) at the same time for 3 seconds until the indicator icon lights up. To deactivate it, press these 2 buttons for 3 seconds again.

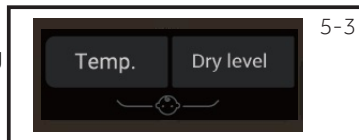

5-3

### Notice

When the power supply is interrupted or turn the knob to off position, the function will not be cancelled automatically.

## 5.3 Delay indicator

When choosing the delay function (Fig.5-4), the icon will light up.

## 5.4 Buzzer indicator

The buzzer is design to alert users with a sound like beep. It is deactivated by default. To activate the buzzer function, Press Delay and i-time buttons at the same time for 3 seconds or until you hear a beep sound.

To deactivate it, press the same 2 buttons for 3 seconds again.



5-4



5-5

5-6



### 5.5 Clean filter indicator

This indicator is designed to remind users to clean filter before using. When this icon (See fig. 5-6) lights up users should clean the filter before use. For the cleaning steps, see Lint filter cleaning or Condenser filter cleaning section of this manual.



### Notice

After each cycle, indicator will twinkle to remind cleaning the filters.

5-7

### 5.6 i-time button

This function is designed to allow users to adjust cycle duration based on personal needs. Only under Timer, Wool, Warm up, Duvet, and i-Refresh programs, users can use this function to adjust time.

5-8

### 5.7 Temp. button

This button is set to adjust drying temperature based on personal needs or requirements.

There are 4 levels and matching display is shown below:

- ┌ - } High temperature.
- ┌ - } Middle temperature.
- ┌ - } Low temperature.
- ┌ 0 } Cool air.

5-9



### 5.8 Start/Pause button

Press Start/Pause (Fig. 5-9) to Start a drying cycle. Press button again to pause the drying cycle. Press button again to continue.

5-10

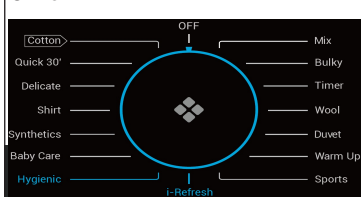

### 5.9 Program knob

Select one of the 15 programs by turning the knob (the OFF is not included) (Fig. 5-10) See Program Modes section of the manual for further information.

5-11

### 5.10 Power

Turn the knob to any position (except OFF) to start the machine. Turn knob the OFF position to shut down the machine (Fig. 5-11).

5-12

### 5.11 Dry Level button

Press the button (Fig. 5-12) to set the final moisture content of the laundry at the end of cycle.

The display is shown below:

- ┌ - } Cupboard
- ┌ - } Ready to wear
- ┌ - } Ironing

### 5.12 Childlock button activation

To activate the Child-lock function after a cycle has been started, press the 2 buttons (Fig. 5-13) for 3 sec. until the indicator icon lights up. To deactivate press the 2 buttons for 3 sec. again.

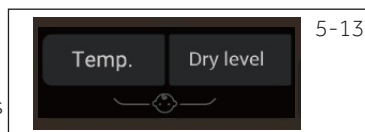

### 5.13 Empty tank indicator

This indicator is designed to remind users the water tank should be emptied (Fig. 5-14).

Important: Empty the water tank after each drying cycle. See Empty the water tank section of the manual.



### 5.14 Display

The display shows the remaining time, the delay time and other related information.

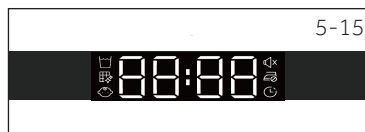

### Notice

The remaining time is a default value, this time will be re-calculated depending on additional program settings and the moisture content of the laundry.

### 5.15 Anti-crease indicator

Anti-crease function is designed to help remove wrinkles of clothes. The drum will rotate after the drying cycle to stretch clothes so there is no need to worry about forgetting to take out clothes. Anti-crease is deactivated by default (Fig.5-16).

after selecting the program, the icon lights up, when the drying cycle ends, the drum will keep rotation for another 1-12 hours with cold wind in. Users can stop it anytime by opening the door or turning off the machine.





Programme	Default drying degree	Laundry	Max. Load kg			Default Time	Temperature
			8	9	10		
<b>Cotton</b>  *)	Ready to wear	For cotton clothes or coats	8	9	10	2:30	60-65°C
<b>Mix</b>	Cupboard	For mixed dry with more than one fabrics	5	6	6.6	2:30	60-65°C
<b>Synthetics</b>	Ready to wear	For those synthetics	4	4.5	5	1:30	50-55°C
<b>Quick 30'</b>	Nonselectable	A fixed 30 minutes dry	0.5	0.5	0.5	0:30	50-55°C
<b>Timer</b>	Nonselectable	For mixed fabrics and users can decide drying time by themselves	-	-	-	0:40	50-55°C
<b>Delicate</b>	Ready to wear	For those delicate fabrics like silk, underwear etc.	2	2	2	1:00	50-55°C
<b>Baby Care</b>	Cupboard	For baby clothes and underwear that needs high temperature sterilization	3	4	4.4	1:20	60-65°C
<b>Wool</b>	Nonselectable	For wool clothes	3	3	3	0:30	50-55°C
<b>Warm Up</b>	Nonselectable	A quick drying cycle to dehumidify clothes and make it warm and comfortable to wear	4	5	5.5	0:30	50-55°C
<b>Duvet</b>	Nonselectable	For feather-filling clothes	1	1	1	1:30	60-65°C
<b>Sports</b>	Ready to wear	For sports wear clothes	4	4.5	5	1:30	60-65°C
<b>i-Refresh**)</b>	Nonselectable	A timer drying cycle for refresh clothes	-	-	-	0:30	50-55°C
<b>Bulky</b>	Cupboard	For heavy and large items like bed sheets or towel etc.	4	4.5	5	2:00	60-65°C
<b>Shirt</b>	Ready to wear	Special for Shirts with 1 hour anti-crease default setting	4	4.5	5	0:40	60-65°C
<b>Hygienic</b>	Cupboard	For fabrics like cotton, mix, sports and so on. Fabrics like wool, silk, shirts, duvet are not suggested to use	-	-	-	3:30	60-65°C

\*) EN 61121 test program setting, we recommend that you drain the condensed water externally through the drain hose when drying a full load using the  program. This will avoid to empty the water tank during the cycle.

\*\*) I-Refresh is a Haier patent-owned function that aims to remove odors and wrinkles, as well as refresh clothes in a short time. By rotate and shake, wind blows in to fresh and stretch clothes, even delicate clothes and unwashed fabrics can be taken good care.

## Heat pump technology

The condensation dryer with heat exchanger is outstanding in terms of efficient energy consumption. These are guide values determined under standard conditions. The values may differ from those given, depending on overvoltage and undervoltage, the type of fabric, composition of the laundry to be dried, the residual moisture and the actual loading.

Program Cotton / Linen (10kg A++)	Spin speed in rpm	Restidual moisture in %	Time in h:min	Energy consumption in kWh
Cupboard 	1000	approx. 60	4:40	2.34
Ready to wear 	1000	approx. 60	4:29	1.98
Ironing 	1000	approx. 60	3:18	1.62



## Environmentally responsible use

- ▶ Spin the laundry as dry as possible before putting it into the tumble dryer.
- ▶ Avoid overloading the tumble dryer.
- ▶ Shake the laundry loose before putting it into the tumble dryer.
- ▶ Choose a proper drying program. Make sure the laundry is not dried longer than needed.
- ▶ Make sure to use the tumble dryer with cleaned filters.

### 8.1 Starched laundry

Starched laundry leaves a film of starch in the drum and is not suitable for the dryer.

### 8.2 Softener

Do not use softener when washing, because the laundry will become soft and fluffy in the dryer.

### 8.3 Soft care cloths

The use of "soft care cloths" can lead to a coating at the lint filters. This can cause a blockage of the filters. In such cases, we recommend either to abstain from adding soft care cloths or to choose a different brand. In any case note the manufacturer's instructions.

### 8.4 Small amounts of filling

In a quantity of less than 1.0 kg, the "Timer"-programme should be selected because the dry level of clothes cannot be sensed sometimes due to the small load.

### 8.5 Open door

The door should be left ajar when not in use, so that the door seal can remain effective for a long time.

### 8.6 Service flap

Make sure that the service flap is always closed during operation.

### 8.7 Anti crease protection

At the end of the cycle, if the laundry is not taken out, the drum moves time to time to prevent creases.

### 8.8 Laundry which should be ironed

For those clothes that needs to be ironed, users should select dry level at "Ironing". Thus, it can help to iron quickly.

### 8.9 Remaining time

The program duration is influenced by the following factors: the type of fabric, the loading quantity, moisture content, the desired dry level, as well as the spin speed during washing. These factors are registered by the electronics during the program and the remaining time will be corrected accordingly.

## 8.10 Extra large pieces

When cycle ends, if the desired dry level is not achieved , loosen up the laundry and dry again with the time program (TIMER ).

## 8.11 Especially delicate fabrics

Textiles which can easily shrink or lose their shape, as well as silk stockings, lingerie should not be put in the dryer directly. Put delicate garments inside a laundry bag and avoid over drying them.

## 8.12 Jersey and knitwear

Clothes like jersey and knitwear, we recommend to use Delicate program to dry to avoid over-drying.

## 8.13 Acoustic signal

An acoustic signal can be activated:

- ▶ when the water tank is full
- ▶ Failures happen

Additionally the acoustic signal can also be selected for following cases:

- ▶ at the end of program
- ▶ when pressing a button
- ▶ when turning the program selector



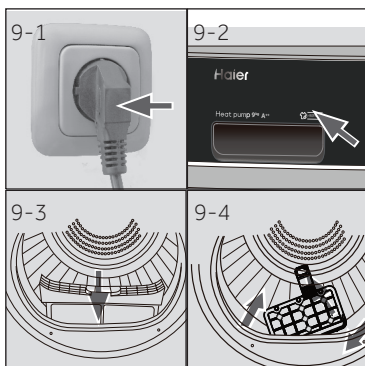

### 9.1 Prepare the appliance

1. Connect the appliance to a power supply (220V to 240V~/50Hz) (Fig. 9-1) Please also refer to section INSTALLATION.
2. Make sure:
  - ▶ the water tank is empty and properly installed. (Fig. 9-2).
  - ▶ the lint filter is clean and properly installed. (Fig. 9-3).
  - ▶ the condenser filter is clean and properly installed (Fig.9-4).

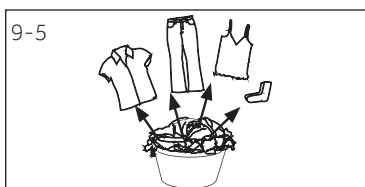

### 9.2 Prepare the laundry

- ▶ Sort clothes according to fabric (cotton, synthetics, wool etc.). Only dry clothes that has been spun.
- ▶ Empty pockets of all sharp or flammable objects such as keys, lighters and matches. Remove hard decorative objects such as brooches.
- ▶ Zippers up and make sure the buttons are sewn on tightly and place small items such as socks, bras etc. in a wash bag.
- ▶ Unfold bulky items of fabric such as bed sheets, table cloth etc.
- ▶ Follow the instructions on the laundry label and dry those garments that can be dried by machine.



### **i** Tips:

- ▶ Separate white clothes from coloured ones.
- ▶ Bed linen and pillowcases should be buttoned, so that small parts cannot stuck inside.
- ▶ Close zippers and hooks, and tie loose belts without metal parts, apron strings etc. together.
- ▶ Remove loose metal parts of clothes before putting into dryer such as metal buttons.
- ▶ Do not over-dry easy-care linen. Risk of creases. Allow final drying in open air.
- ▶ Clothes like knitwear can be over-drying sometimes. "Ironing" dry level are always recommended to choose.
- ▶ For pre-dried, multi-layered garments or for final drying the time-programme (TIMER) should be chosen.

Load Reference	Composition	Average weight per item
Bed sheet (single)	Cotton	Approx. 800 g
Blended fabric clothes	/	Approx. 800 g
Jackets	Cotton	Approx. 800 g
Jeans	/	Approx. 800 g
Overalls	Cotton	Approx. 950 g
Pyjamas	/	Approx. 200 g
Shirts	/	Approx. 300 g
Socks	Blended fabrics	Approx. 50 g
T-Shirts	Cotton	Approx. 300 g
Underwear	Blended fabrics	Approx. 70 g

### 9.3 Load clothes the appliance

- ▶ Loosen up and insert presorted laundry.
- ▶ Don't overload.
- ▶ Close the door carefully. Make sure that clothes are not pinched.

### 9.4 Take out and add clothes

To remove or add clothes, the program can be interrupted at any time:

- ▶ The cycle will be interrupted if opening the door.  
Be careful when taking out or adding clothes! The interior of the drum or the clothes itself may be hot, so that there is danger of burns.
- ▶ To continue the program, press the "Start/Pause" button after closing the door.



#### CAUTION!

Non-textile, as well as small, loose or sharp-edged items may cause malfunctions and damage of clothes and appliance.



#### WARNING!

Never turn the dryer off before the end of the drying cycle unless all items are quickly removed and spread out so that the heat can be released.

### 9.5 Loading the dryer

1. Place the laundry evenly in the drum making sure not to overload the dryer.
2. Turn the knob to any position (except OFF) to start the machine.(Fig. 9-7).

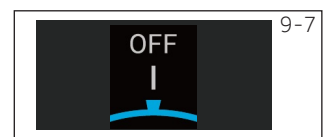

## Notice

Fabric softeners or similar products should be used as specified in the manufacturer's instructions.

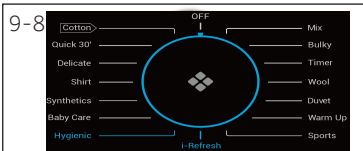

### 9.6 Set program and start

1. Select one of the 15 programs by turning the knob (the OFF is not included) (Fig. 9.8), and its default settings will be displayed.
2. Set functions such as Temperature, Dry level, Delay. Afterwards press the Start/Pause button (Fig. 9-9) to start the dry cycle.

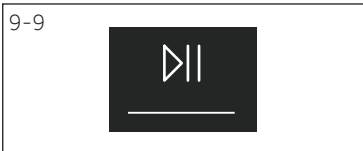

### 9.7 End of dry cycle

The tumble dryer stops operation automatically when a dry cycle is complete. The display shows END about 5S. Open the tumble dryer door and take out clothes. If clothes are not taken out, the wrinkle free function will start automatically and the screen shows 0:00 (This function is only available for some programs)

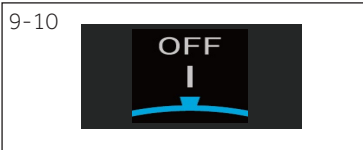

1. Turn the knob to the OFF position to shut down the machine (Fig. 9-10).
2. Unplug the tumble dryer from the power socket (Fig. 9-11).

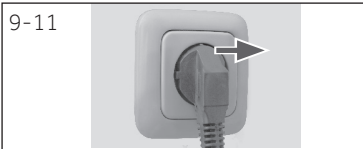

3. Empty the water tank after each dry cycle (Fig. 9-12).

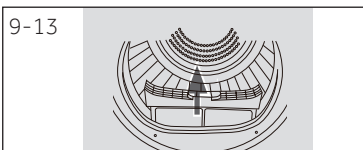



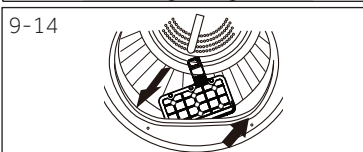



















4. Clean the lint filter after each dry cycle (Fig. 9-13).



5. Clean the condenser filter after each dry cycle (Fig. 9-14).

## Care chart

Washing		
 Washable up to 95°C normal process	 Washable up to 60°C normal process	 Washable up to 60°C mild process
 Washable up to 40°C normal process	 Washable up to 40°C mild process	 Washable up to 40°C very mild process
 Washable up to 30°C normal process	 Washable up to 30°C mild process	 Washable up to 30°C very mild process
 Wash by hand max. 40°C	 Do not wash	
Bleaching		
 Any bleaching allowed	 Only oxygen/ non -chlorine	 Do not bleach
Drying		
 Tumble drying possible normal temperature	 Tumble drying possible lower temperature	 Do not tumble dry
 Line drying	 Flat drying	
Ironing		
 Iron at a maximum temperature up to 200 °C	 Iron at a medial temperature up to 150°C	 Iron at a low temperature up to 110 °C; without steam (steam ironing may cause irreversible damage)
 Do not iron		

10-1

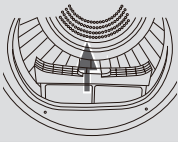
**10.1 Lint filter cleaning**

Clean the lint filter after each dry cycle.

1. Remove the lint filter from the drum (Fig. 10-1).

10-2

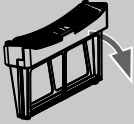

2. Open up the lint filter (Fig. 10-2).

10-3

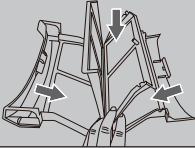

3. Remove the lint residuals from lint filter (Fig. 10-3).

10-4

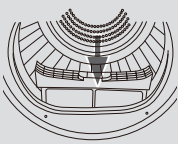

4. Reinstall the cleaned lint filter in the tumble dryer (Fig. 10-4).

10-5

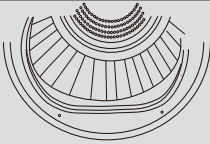
**10.2 Condenser filter cleaning**

Clean the filter after each dry cycle.

1. Open the door.

2. Pull out the lint filter from front duct (Fig. 10-6).

10-6

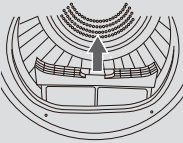

3. Pull out the condenser filter from the air duct (Fig. 10-7).

10-7

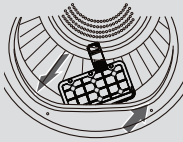

4. Separate the sponge and clean the filter the sponge and clean the filter screen form any residuals (Fig. 10-8).

10-8

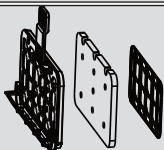

5. Reinstall the sponge to the condenser filter and put it back into the duct.

**Notice**

If the lint / the condenser filter is very dirty, it can be cleaned under running water. Let it dry completely before use.

## 10.3 Empty the water tank

During operation, steam is condensed into water and collected in the water tank. Empty the water tank after each drying cycle.

1. Pull out the water tank from its housing (Fig. 10-9).
2. Empty the water tank (Fig. 10-10).
3. Reinstall the water tank to the tumble dryer (Fig. 10-11).



### Notice

Do not use the water for any kind of drinking or food processing.

## 10.4 Tumble dryer

Wipe the outside of the tumble dryer and the control panel with a damp cloth. Do not use any organic solvent or corrosive agent to avoid damage to the device.

## 10.5 Drum

After running for a while, micro elements like calcium and mineral substances contained in the water will result in an invisible film formed inside the drum. Use a damp cloth and some detergent to remove it. Do not use any organic solvent or corrosive agent to avoid damage to the device.

## 10.6 Evaporator

If the evaporator behind the condenser filter is dirty, it can be cleaned by using a vacuum cleaner. Make sure not to damage the evaporator while cleaning it.

Many problems can be solved by yourself without specific expertise. please check all shown possibilities and follow below instructions before you contact an after sales service. See CUSTOMER SERVICE.



## WARNING!

- ▶ Before maintenance, turn off the appliance and disconnect the mains plug from the socket.
- ▶ Electrical equipment should be serviced only by qualified electrical experts, because improper repairs can cause considerable consequential damages.
- ▶ A damaged power cable should only be replaced by the manufacturer, its service agent or similarly qualified workers in order to avoid a hazard.

### Troubleshooting with display code

Code	Cause	Solution
F2	Drain pump error.	Contact the customer service.
F32 F33	The condenser thermal sensor is open-circuited or short-circuited.	Contact the customer service.
F4	Temperature of the laundry in the drum does not change.	Contact the customer service.
FE2	Communication failure between PCB and display.	Contact the customer service.
LD	Temperature is too low.	Use the dryer when air temperature is higher than 5 °C.

if the error codes appear again after taking measures, switch off the appliance, disconnect the power supply and contact the customer service.

## Troubleshooting without display-codes

Problem	Possible cause	Possible solution
Tumble dryer fails to operate.	<ul style="list-style-type: none"> <li>• Poor connection to the power supply.</li> <li>• Power failure.</li> <li>• No drying program is set.</li> <li>• Device has not been switched on.</li> <li>• The water tank is full.</li> <li>• The door is not closed properly.</li> </ul>	<ul style="list-style-type: none"> <li>• Check connection to the power supply.</li> <li>• Check the power supply.</li> <li>• Set a drying program.</li> <li>• Switch on the device.</li> <li>• Empty the water tank.</li> <li>• Close the door properly.</li> </ul>
Tumble dryer fails to operate and the display shows <b>End</b> .	<ul style="list-style-type: none"> <li>• The laundry has reached the dry level defined by the programme.</li> </ul>	<ul style="list-style-type: none"> <li>• Check the program setting is appropriate or not.</li> </ul>
Drying time is too long and the results are not satisfactory	<ul style="list-style-type: none"> <li>• The programme setting is not correct.</li> <li>• The filter is clogged.</li> <li>• The evaporator is blocked.</li> <li>• The tumble dryer is overloaded.</li> <li>• The laundry is too wet.</li> <li>• The vent duct is blocked.</li> </ul>	<ul style="list-style-type: none"> <li>• Make sure the program is set correctly.</li> <li>• Clean the filter screen.</li> <li>• Clean the evaporator.</li> <li>• Reduce the amount of laundry.</li> <li>• Spin the laundry completely before drying.</li> <li>• Check and clean the vent duct.</li> </ul>
Remaining time-on the display-stops or skips.	<p>The remaining time will be adjusted continuously based upon the following factors:</p> <ul style="list-style-type: none"> <li>• fabric of laundry.</li> <li>• loading weight.</li> <li>• Moisture degree of the laundry.</li> <li>• Ambient temperature.</li> </ul>	<p>The automatic adjustment is a normal operation.</p>



**Notice: all installation relevant pictures can be found at the beginning of this manual.**

### 12.1 Preparation

- ▶ Remove all packages including the polystyrene base firstly. While removing the package, water drops may be observed. This is normal phenomenon results from water test the factory.



#### Notice

Dispose of the package in an environmental friendly manner. For information referring to current disposal sites, consult your retailer or the local authorities.



#### WARNING!

After transportation and installation, you **MUST** leave the dryer to stand for two hours before use.

### 12.2 Transport and waiting time

Transport the appliance in horizontal position only. To the maintenance-free lubrication oil is located in the capsule of the compressor. This oil can get through the closed pipe system during slanting transport. Before connecting the appliance to the power supply you have to wait 2 hours so that the oil runs back into the capsule.

### 12.3 Place the appliance

The appliance should be placed on a flat and solid surface. Set the feet to the desired level(Fig.12-1).

### 12.4 Installation under worktop

The dimensions of the recess should at least match with the dimensions(Fig.12-2)

1. Put the appliance adjacent to the slot. Make sure that all connections are easily accessible and functional.
2. Adjust accurately all feet to get a firm level position.
3. Install the appliance prudently into the recess.
4. Make sure a sufficient ventilation.

### 12.5 Electrical connection

Before each connection check if:

- ▶ power supply, socket and fusing are appropriate to the rating plate.
- ▶ the power socket is earthed and no multi-plug or extension.
- ▶ the power plug and socket are strictly match.
- ▶ **Only UK:** The UK plug meets BS1363A standard

Put the plug into the socket(Fig.12-3).



#### WARNING!

If the supply cord is damaged, it must be replaced by the service agent (see warranty card) in order to avoid a hazard!

## 12.6 Wash-dryer stack

It is possible to achieve a washer-dryer stack, is possible (Fig. 12-8). Not every washing machine is suitable for this purpose. Stacking information, as well as the corresponding mounting kit are available via your local dealer.

The mounting instructions are supplied with the kit which thoroughly inform the installation steps.

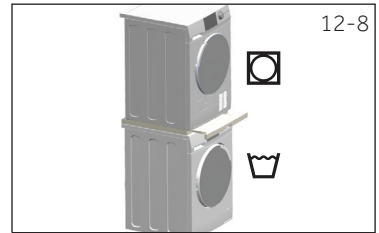

## 12.7 level the dryer

It is **IMPORTANT** to level the dryer to ensure the machine runs efficiently with minimal noise. The dryer should be levelled in as close to its final position as possible so it stands balanced evenly on all four feet. Ensure the dryer does not rock in any direction.

### Level the dryer side to side(Fig.12-9):

- Place the gradienter at the centre back of the dryer.
- Adjust the rear feet until the dryer is level side to side.
- Never fully screw the feet completely from their housings.

### Level the dryer front to back(Fig.12-10):

- Place the gradienter on the left side.
- Adjust the front left foot (wind down).
- Repeat the above for the right foot.

### Double check the dryer is balanced(Fig.12-10):

- Place the gradienter at the centre front of the dryer.
- Ensure the dryer does not rock in any direction.
- If dryer is not balanced repeat the above steps.

After levelling, the corners of the dryer cabinet should be clear of the floor and the dryer must not rock in any direction.

## 12.8 Draining

The dryer is equipped with a condenser unit which accumulates water during the drying cycle. This water is collected in the removable water tank located at the top left of the dryer. The accumulated water must be emptied after each drying cycle or you can setup your dryer to drain automatically using the drain hose provided.

We recommend the dryer is set up to drain automatically where possible especially when drying full loads, this will avoid having to empty the water tank during a drying cycle.

### Connecting the drain hose

- Remove the black hose from the connection at the back of the dryer(Fig.12-11).
- Uncoil the drain hose (included with your dryer) and connect it to the black hose(Fig.12-12).
- Place the other end of the drain hose into a tub or standpipe(Fig.12-13).

## Productfiche (acc. to EU 392/2012)

Trade mark	Haier			
Model identifier	HD80-A2939 HD80-A2939S	HD90-A2939 HD90-A2939S	HD100-A2939 HD100-A2939S	HD90-A3939 HD90-A3939S
Rated capacity (kg)	8	9	10	9
Kind of tumble drier	Condenser			
Energy efficiency class	A++	A++	A++	A+++
Weighted Annual Energy Consumption (AE <sub>c</sub> in kWh/year) <sup>1)</sup>	235	265	286	200
Tumble dryer with or without automatic	with automatic			
Energy consumption of the standard cotton programme <sup>3)</sup> at full load (kWh/cycle)	1.88	2.10	2.40	1.58
Energy consumption of the standard cotton programme <sup>3)</sup> at partial load (kWh/cycle)	1.02	1.20	1.29	0.89
Power consumption of the off-mode (W)	0.70	0.70	0.70	0.48
Power consumption of the left-on mode (W)	0.75	0.75	0.75	0.62
Duration of the „left-on mode“ (min) <sup>2)</sup>	40			
Standard drying programme <sup>3)</sup>				
Weighted programme time of the standard drying programme <sup>3)</sup> at full and partial load (min)	155	180	190	150
Programme time of the standard cotton programme <sup>3)</sup> at full load (min)	200	235	260	190
Programme time of the standard cotton programme <sup>3)</sup> at partial load (min)	120	140	145	118
Condensation efficiency class <sup>4)</sup>	B	B	B	B
Weighted condensation efficiency for the standard cotton programme <sup>3)</sup> at full and partial load (%)	83	80.8	80.3	85
Average condensation efficiency of the standard cotton programme <sup>3)</sup> at full load	81	80	80	85.5
Average condensation efficiency of the standard cotton programme <sup>3)</sup> at partial load	85	81.5	80.6	84.5
Weighted sound power level of the standard cotton programme <sup>3)</sup> at full load (dB)	65			
Built-in or freestanding	Freestanding/ built under			

- 1) Based on 160 drying cycles of the standard cotton program at full and partial load, and the consumption of the low-power modes. Actual energy consumption per cycle will depend on how the appliance is used.
- 2) In case there is a power management system.
- 3) This program used at full and partial load is the standard drying program to which the information in the label and the fiche relates to. This is the program suitable for drying normal wet cotton laundry and it is the most efficient program in terms of energy consumption for cotton.
- 4) Class G is the least efficient and Class A is the most efficient.

### Additional data

Power supply (refer to rating plate) - voltage / current / input	220–240 V~50 Hz/ 2.4 A/ 550 W (A+++) /630W(A++)
Permissible ambient temperature	5°C to 35°C
Fluorinated greenhouse gas	HFC-134a
Volume	0.26 kg (A++) 0.28 kg (A+++)
GWP	1430
Tonne(s) of CO <sub>2</sub> equivalent	0.6

### Product dimensions

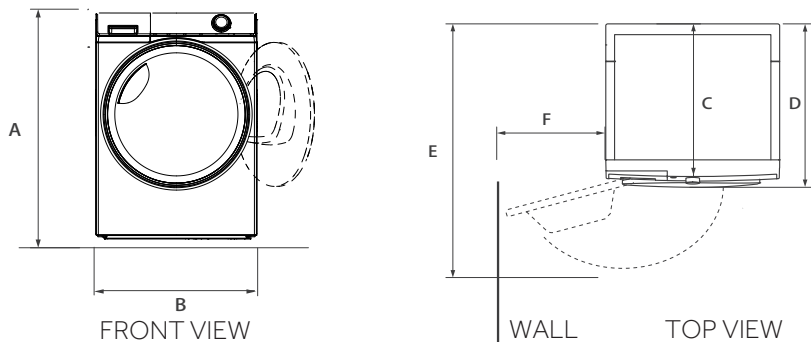

PRODUCT DIMENSIONS	HD90/80
A Overall height of product mm	850
B Overall width of product mm	595
C Overall depth of product (To main control board size) mm	600
D Overall depth of product mm	665
E Depth of door open mm	1135
F Minimum door clearance to adjacent wall mm	250

Note: The exact height of your dryer is dependent on how far the feet are extended from the base of the machine. The space where you install your dryer needs to be at least 40mm wider and 20mm deeper than its dimensions.

We recommend our Haier Customer Service and the use of original spare parts.  
If you have a problem with your appliance, please first check section TROUBLESHOOTING.

If you cannot find a solution there, please contact

- ▶ your local dealer or
- ▶ the Service & Support area at [www.haier.com](http://www.haier.com) where you can find telephone numbers and FAQs and where you can activate the service claim.

To contact our Service, ensure that you have the following data available.  
The information can be found on the rating plate.

Model \_\_\_\_\_ Serial No. \_\_\_\_\_

Also check the Warranty Card supplied with the product in case of warranty.

For general business enquiries please find below our addresses in Europe:

European Haier addresses			
Country*	Postal address	Country*	Postal address
<b>Italy</b>	Haier Europe Trading SRL Via De Cristoforis, 12 21100 Verese ITALY	<b>France</b>	Haier France SAS 53 Boulevard Ornano – Pleyad 3 93200 Saint Denis FRANCE
<b>Spain Portugal</b>	Haier Iberia SL Pg. Garcia Faria, 49-51 08019 Barcelona SPAIN	<b>Belgium-FR Belgium-NL Netherlands Luxembourg</b>	Haier Benelux SA Anderlecht Route de Lennik 451 BELGIUM
<b>Germany Austria</b>	Haier Deutschland GmbH Konrad-Zuse-Platz 6 81829 München GERMANY	<b>Poland Hungary Greece Romania Russia</b>	Haier Poland Sp. zo.o. Al. Jerozolimskie 181B 02-222 Warszawa POLAND
<b>United Kingdom</b>	Haier Appliances UK Co.Ltd. 302 Bridgewater Place Birchwood Park Warrington WA3 6x	<b>Czech Republic and Slovakia</b>	Haier Europe ČR s.r.o. Sokolovská 651/136a, 186 00 Praha 8 Karlín Czech Republic

\*For more information please refer to [www.haier.com](http://www.haier.com)

HD80-A2939/HD80-A2939S/HD90-A2939/HD90-A2939S/HD100-A2939/HD100-A2939S/HD90-A3939/HD90-A3939S

**Haier**

